

Geek Family

- All with dimension of 75mm, a collection of diverse but uniform illuminators for architects and lighting designers;
- Module design makes the system changeable in colors, beam angles, IP20/IP44, stretchable, snout, and twins spots, to meet the various needs of the designers;
- With magnetic fixing structure, the modules are easy installed and maintained.
- Cold-forged aluminum heat dissipation is twice the die-casting, extending its lifespan.



CRI97



Modular Design



Magnetic Fixed



Cold-Forged Heat Sink



Fully Metal-made



Size 75mm

GEEK Family Applications

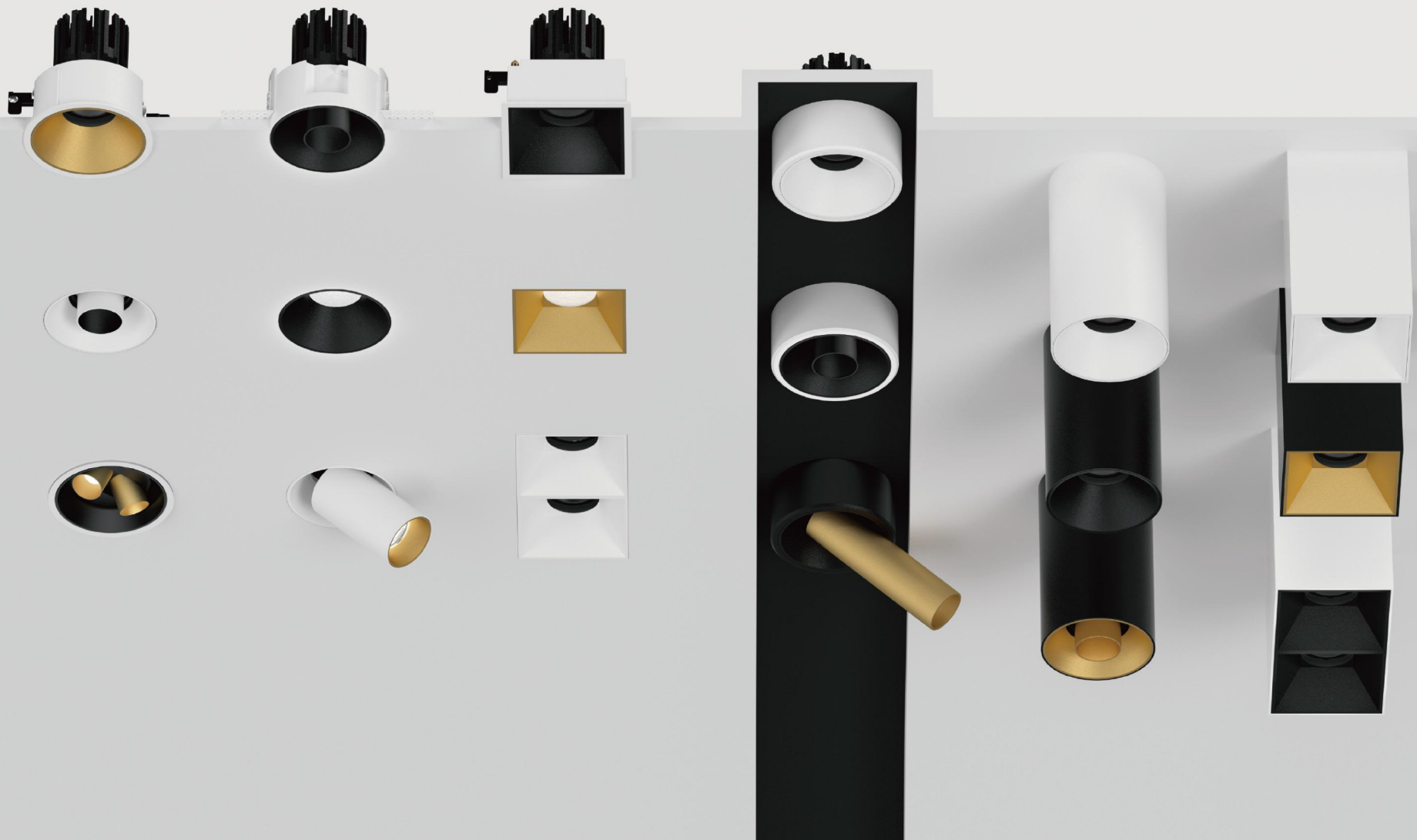

GEEK Standard Structure



Family Specification

	GEEK Round						GEEK Square		GEEK Surface	
Picture										
Cutout Size	75mm/2.95"						75*75mm/2.95"*2.95"		/	
Power max.	15W	15W	10W	8W	15W	8W	15W		10W	
Input Voltage	DC36V						DC36V	DC36V		DC36V
CRI	97Ra/90Ra						90Ra	97Ra/90Ra		97Ra/90Ra
Lumens	65lm/W / 90lm/W						40lm/W	65lm/W / 90lm/W		65lm/W / 90lm/W
CCT	3000K ● 3500K ● 4000K ○						3000K ● 3500K ● 4000K ○		3000K ● 3500K ● 4000K ○	
CCT Changeable	2700K 6000K / 1800K 3000K						/	2700K 6000K / 1800K 3000K		
Light Source	LED COB (Constant Current)						LED COB (Constant Current)	LED COB (Constant Current)		LED COB (Constant Current)
Beam Angle	15° 25° 35° 50°		15° 25°		15° 25° 35°		15° 25°		15° 25° 35° 50°	
Light Direction	25° 360° Fixed		50° 360°		20° 360°		2*25° 360°		25° 360° Fixed	
IP Rating	IP20	IP44	IP20	IP20	IP20	IP20	IP20	IP44	IP20	
Finishing Color	Black White						Black White		Black White	
Reflector Color	Black White Golden						Black White Golden		Black White Golden	
Material	Pure Alu. (Heat Sink)/Die-casting Alu. (Reflector&Embedded Part)									
Driver Voltage	AC100-120V AC220-240V						AC100-120V AC220-240V		AC100-120V AC220-240V	
Driver Options	ON/OFF		DIM TRIAC/ PHASE-CUT			DIM 0/1-10V		DIM DALI		
Ceiling Applications	-With Trim		-Trimless		-Semi-recessed		-Surface Mounted			

GEEK Round

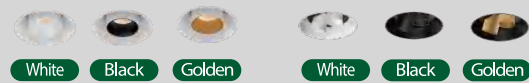
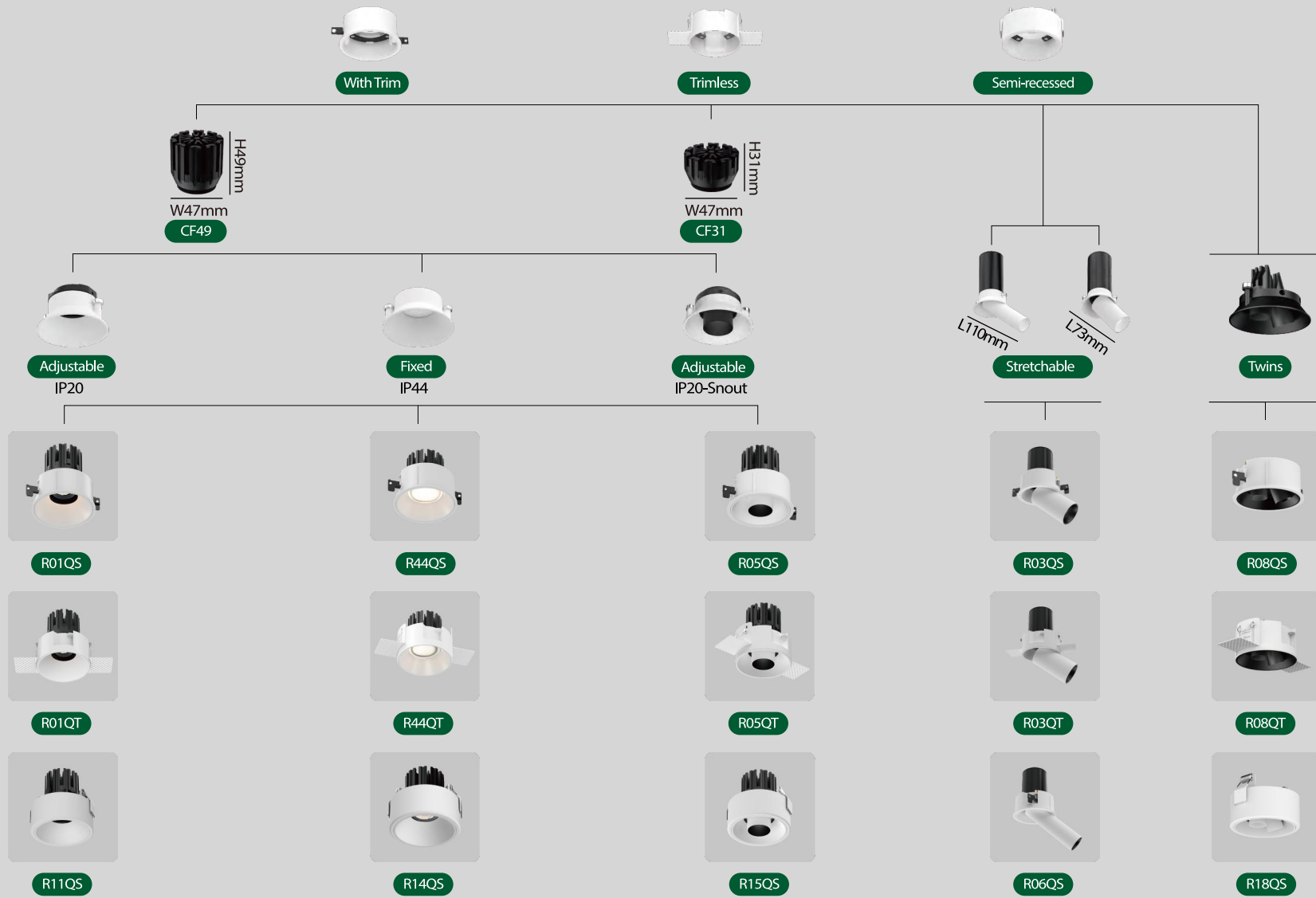

GEEK Round



GK75-R01QS

GK75-R01QT

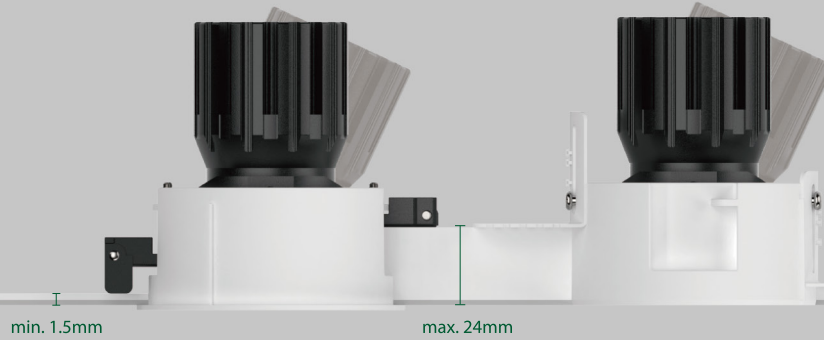

min. 1.5mm

max. 24mm

With Trim

Trimless

White



Black



Golden

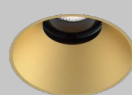
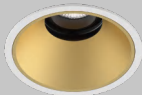

Black Mirror

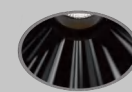
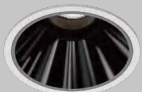

GK75-R01QS

25° / 360°



81mm
3.19"

GK75-R01QT

25° / 360°



74mm
2.91"

85mm
3.35"

85mm
3.35"

Basic Information

Model	GK75-R01QS/R01QT
Embedded Parts	With Trim/Trimless
Mounting	Recessed
Trim Finishing Color	White/Black
Reflector Color	White/Black/Golden/ Black Mirror
Material	Cold Forged Pure Alu. (Heat Sink)/Die-casting Alu.
Cutout Size	∅ 75mm
Light Direction	25° 360°
IP Rating	IP20
Power	Max. 15W
Input Voltage	DC36V
Input Current	Max. 350mA

Optical Parameters

Light Source	LED COB
Lumens	65lm/W 90lm/W
CRI	97Ra / 90Ra
CCT	3000K ● 3500K ● 4000K ○
CCT Changeable	2700K — 6000K 1800K — 3000K
Beam Angle	15° 25° 35° 50°
Shielding Angle	50°
UGR	< 13
LED Lifespan	50000hrs

Driver Voltage	AC100-120V AC220-240V
Driver Options	ON/OFF DIM TRIAC/ PHASE-CUT DIM 0/1-10V DIM DALI

Geek Family

GEEK Round IP44



Geek Family

GK75-R44QS

GK75-R44QT

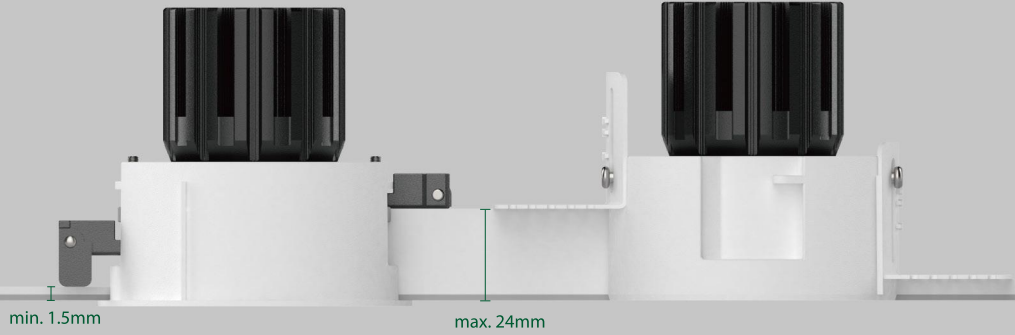

With Trim

Trimless

White

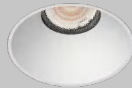

Black



Golden

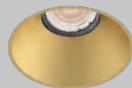
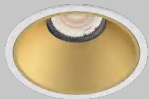

Black Mirror

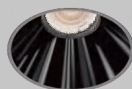
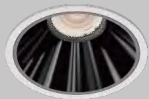

GK75-R44QS

GK75-R44QT

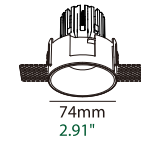
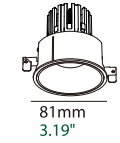

Basic Information

Model	GK75-R44QS/R44QT
Embedded Parts	With Trim/Trimless
Mounting	Recessed
Trim Finishing Color	White/Black
Reflector Color	White/Black/Golden/ Black Mirror
Material	Cold Forged Pure Alu. (Heat Sink)/Die-casting Alu.
Cutout Size	∅ 75mm
Light Direction	Fixed
IP Rating	IP44
Power	Max. 15W
Input Voltage	DC36V
Input Current	Max. 350mA

Optical Parameters

Light Source	LED COB
Lumens	65lm/W 90lm/W
CRI	97Ra / 90Ra
CCT	3000K ● 3500K ● 4000K ○
CCT Changeable	2700K — 6000K 1800K — 3000K
Beam Angle	15° 25° 35° 50°
Shielding Angle	35°
UGR	< 16
LED Lifespan	50000hrs

Driver Voltage AC100-120V AC220-240V

Driver Options ON/OFF DIM TRIAC/ PHASE-CUT DIM 0/1-10V DIM DALI

GEEK Stretchable



GK75-R03QS

GK75-R03QT

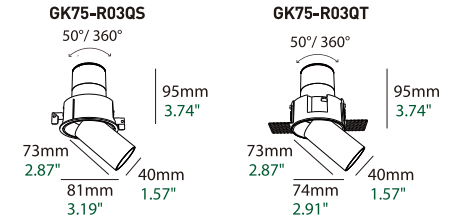
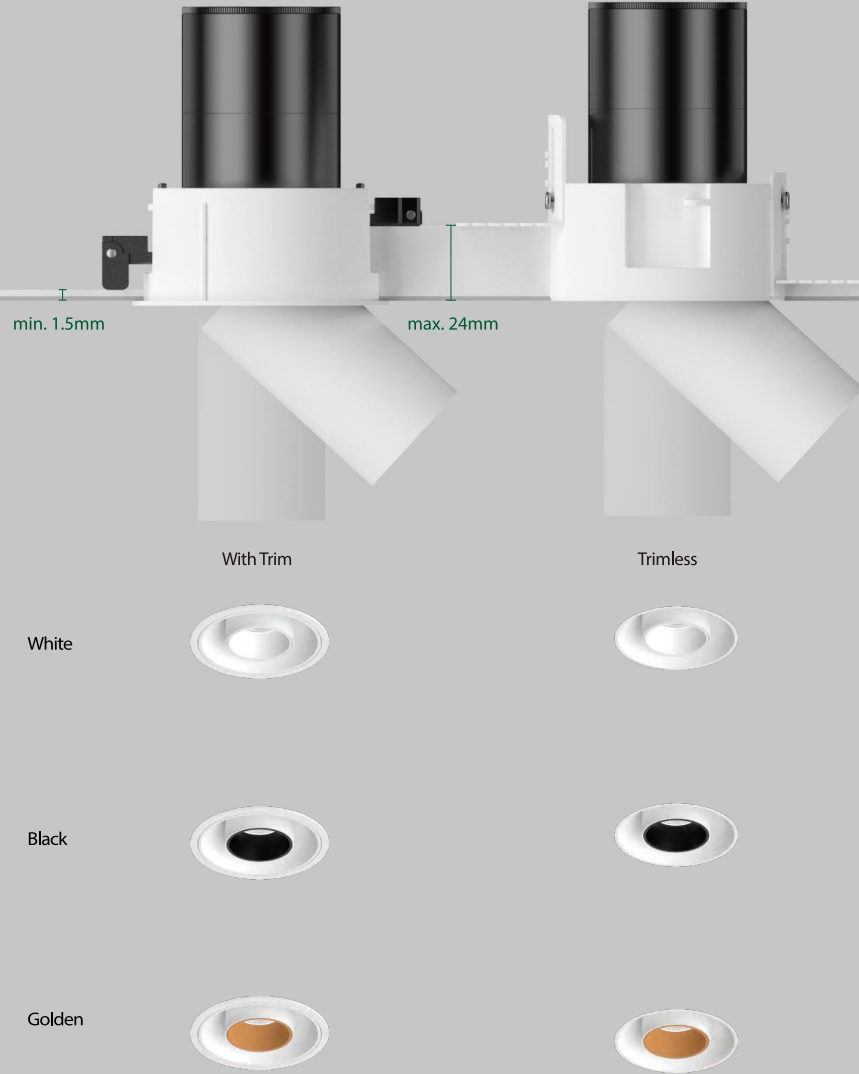

Basic Information

Model	GK75-R03QS/R03QT
Embedded Parts	With Trim/Trimless
Mounting	Recessed
Trim Finishing Color	White/Black
Reflector Color	White/Black/Golden
Material	Pure Alu. (Heat Sink)/Die-casting Alu.
Cutout Size	∅ 75mm
Light Direction	50° 360°
IP Rating	IP20
Power	Max. 10W
Input Voltage	DC36V
Input Current	Max. 250mA

Optical Parameters

Light Source	LED COB
Lumens	65lm/W 90lm/W
CRI	97Ra / 90Ra
CCT	3000K 3500K 4000K
CCT Changeable	2700K 6000K 1800K 3000K
Beam Angle	15° 25°
Shielding Angle	45°
UGR	< 13
LED Lifespan	50000hrs

Driver Voltage	AC100-120V AC220-240V
Driver Options	ON/OFF DIM TRIAC/ PHASE-CUT DIM 0/1-10V DIM DALI

GEEK Stretchable L



GK75-R06QS

GK75-R06QT

min. 1.5mm

max. 24mm

With Trim

Trimless

White

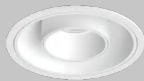

Black

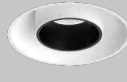
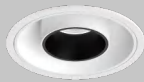

Golden

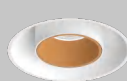
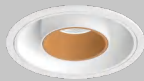

GK75-R06QS

50° / 360°

81mm 3.19"

50mm 1.97"

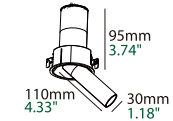

GK75-R06QT

50° / 360°

74mm 2.91"

50mm 1.97"

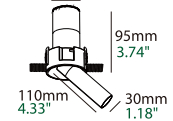

Basic Information

Model	GK75-R06QS/R06QT
Embedded Parts	With Trim/Trimless
Mounting	Recessed
Trim Finishing Color	White/Black
Reflector Color	White/Black/Golden
Material	Pure Alu. (Heat Sink)/Die-casting Alu.
Cutout Size	75mm
Light Direction	50° / 360°
IP Rating	IP20
Power	Max. 8W
Input Voltage	DC36V
Input Current	Max. 200mA

Optical Parameters

Light Source	LED COB
Lumens	65lm/W 90lm/W
CRI	97Ra / 90Ra
CCT	3000K ● 3500K ● 4000K ○
CCT Changeable	2700K — 6000K 1800K — 3000K
Beam Angle	15° 25°
Shielding Angle	62°
UGR	< 9
LED Lifespan	50000hrs

Driver Voltage AC100-120V AC220-240V

Driver Options ON/OFF DIM TRIAC/ PHASE-CUT DIM 0/1-10V DIM DALI

GEEK Snout



GK75-R05QS

GK75-R05QT

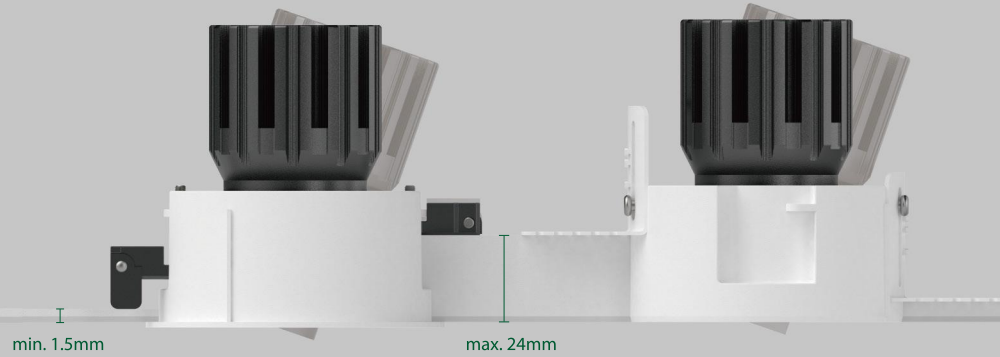

With Trim

Trimless

White

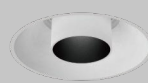
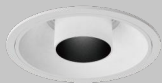

Black



Golden

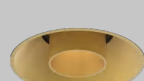
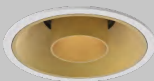

GK75-R05QS

20°/360°



31mm
1.22"
81mm
3.19"

GK75-R05QT

20°/360°



31mm
1.22"
74mm
2.91"

Basic Information

Model	GK75-R05QS/R05QT
Embedded Parts	With Trim/Trimless
Mounting	Recessed
Trim Finishing Color	White/Black
Reflector Color	White/Black/Golden
Material	Cold Forged Pure Alu. (Heat Sink)/Die-casting Alu.
Cutout Size	75mm
Light Direction	20° 360°
IP Rating	IP20
Power	Max. 15W
Input Voltage	DC36V
Input Current	Max. 350mA

Optical Parameters

Light Source	LED COB
Lumens	65lm/W 90lm/W
CRI	97Ra / 90Ra
CCT	3000K 3500K 4000K
CCT Changeable	2700K 6000K 1800K 3000K
Beam Angle	15° 25° 35°
Shielding Angle	67°
UGR	< 9
LED Lifespan	50000hrs

Driver Voltage	AC100-120V AC220-240V
Driver Options	ON/OFF DIM TRIAC/ PHASE-CUT DIM 0/1-10V DIM DALI

GEEK Twins



Geek Family

GK75-R08QS

GK75-R08QT

min. 1.5mm

max. 24mm

With Trim

Trimless

White

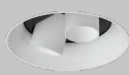
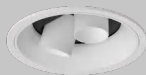

Black

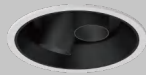

Golden

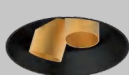
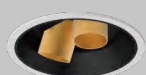

GK75-R08QS

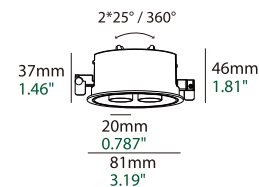

GK75-R08QT

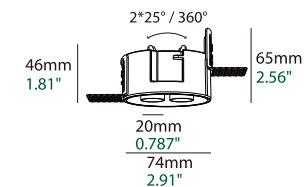

Basic Information

Model	GK75-R08QS/R08QT
Embedded Parts	With Trim/Trimless
Mounting	Recessed
Trim Finishing Color	White/Black
Reflector Color	White/Black/Golden
Material	Pure Alu. (Heat Sink)/Die-casting Alu.
Cutout Size	∅ 75mm
Light Direction	⬇ 2*25° ⬅ 360°
IP Rating	IP20
Power	Max. 8W
Input Voltage	DC36V
Input Current	Max. 180mA

Optical Parameters

Light Source	LED COB
Lumens	40lm/W
CRI	90Ra
CCT	3000K ● 3500K ● 4000K ○
Beam Angle	⬆ 15° ⬆ 25°
LED Lifespan	50000hrs

Driver Voltage	AC100-120V AC220-240V
Driver Options	ON/OFF DIM TRIAC/ PHASE-CUT DIM 0/1-10V DIM DALI

GEEK Semi-recessed



GEEK Round

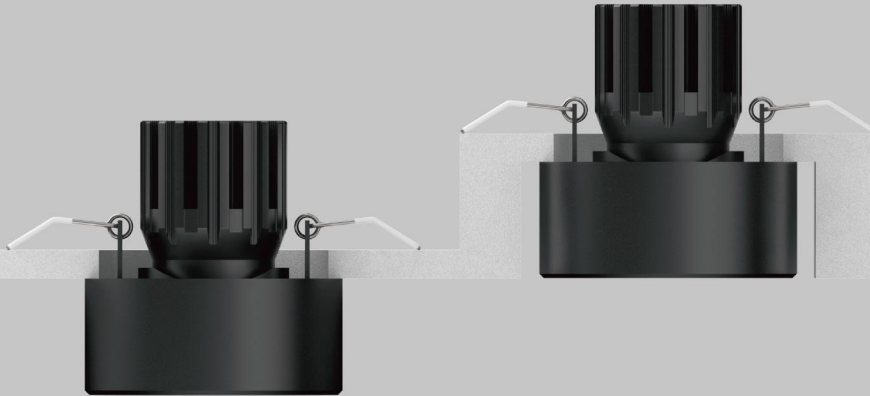

Basic Information

Model	GK75-R11QS
Mounting	Semi-recessed
Power	Max. 15W
CCT	3000K <input type="radio"/> 3500K <input type="radio"/> 4000K <input type="radio"/>
Beam Angle	<input type="checkbox"/> 15° <input type="checkbox"/> 25° <input type="checkbox"/> 35° <input type="checkbox"/> 50°
UGR	< 13
IP Rating	IP20
Lumens	65lm/W 90lm/W
CRI	97Ra /90Ra

Driver Voltage	AC100-120V AC220-240V
Driver Options	ON/OFF DIM TRIAC/ PHASE-CUT DIM 0/1-10V

GK75-R11QS

25°/360°



GEEK Semi-recessed



GEEK Round IP44



Geek Family

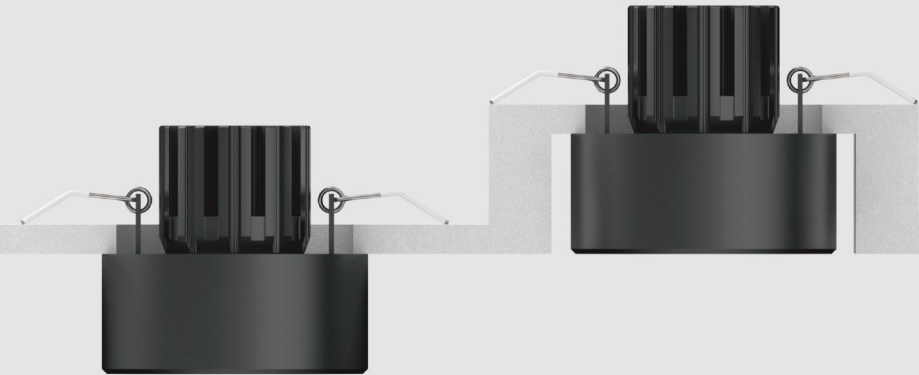

Basic Information

Model	GK75-R14QS
Mounting	Semi-recessed
Power	Max. 15W
CCT	3000K <input type="radio"/> 3500K <input type="radio"/> 4000K <input type="radio"/>
Beam Angle	<input type="checkbox"/> 15° <input type="checkbox"/> 25° <input type="checkbox"/> 35° <input type="checkbox"/> 50°
UGR	< 16
IP Rating	IP44
Lumens	65lm/W 90lm/W
CRI	97Ra /90Ra

Driver Voltage	AC100-120V AC220-240V
Driver Options	ON/OFF DIM TRIAC/ PHASE-CUT DIM 0/1-10V

GK75-R14QS

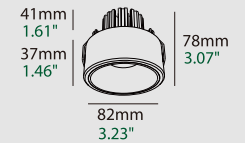

GEEK Semi-recessed



Geek Family

GEEK Stretchable

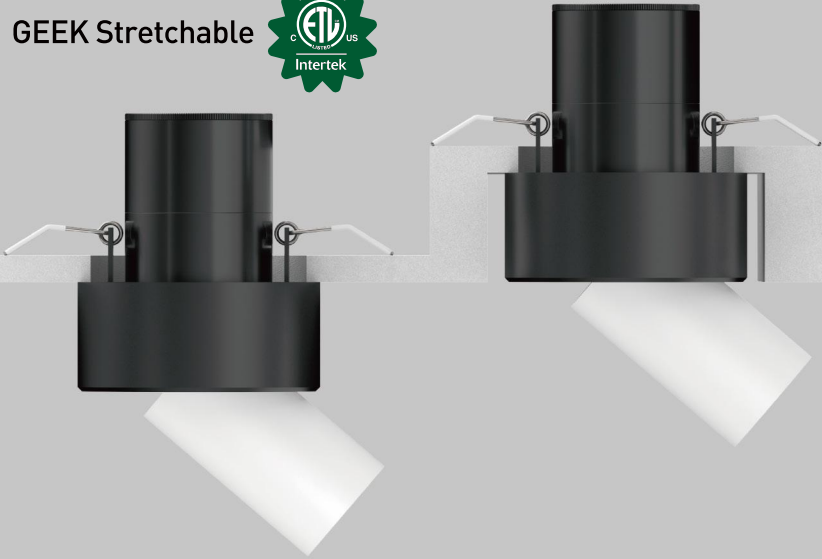

Basic Information

Model	GK75-R13QS
Mounting	Semi-recessed
Power	Max. 10W
CCT	3000K ● 3500K ● 4000K ●
Beam Angle	15° 25°
UGR	< 13
IP Rating	IP20
Lumens	65lm/W 90lm/W
CRI	97Ra /90Ra

Driver Voltage	AC100-120V AC220-240V
Driver Options	ON/OFF DIM TRIAC/ PHASE-CUT DIM 0/1-10V

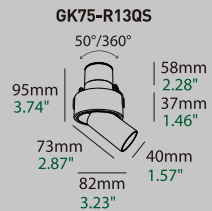

GEEK Semi-recessed



GEEK Stretchable L

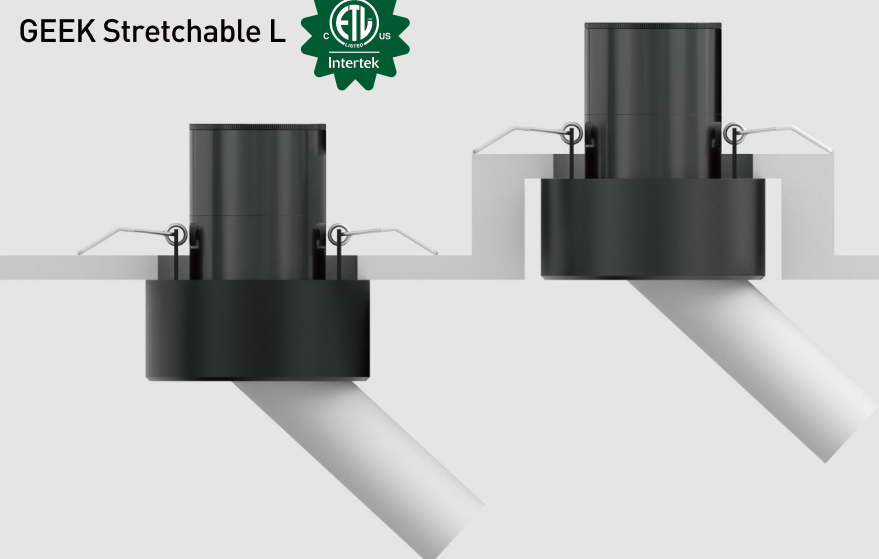

Basic Information

Model	GK75-R16QS
Mounting	Semi-recessed
Power	Max. 8W
CCT	3000K ● 3500K ● 4000K ●
Beam Angle	15° 25°
UGR	< 9
IP Rating	IP20
Lumens	65lm/W 90lm/W
CRI	97Ra /90Ra

Driver Voltage	AC100-120V AC220-240V
Driver Options	ON/OFF DIM TRIAC/ PHASE-CUT DIM 0/1-10V

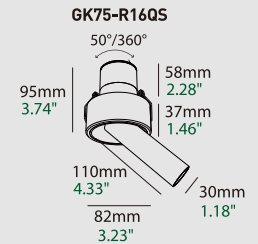

GEEK Semi-recessed



GEEK Snout

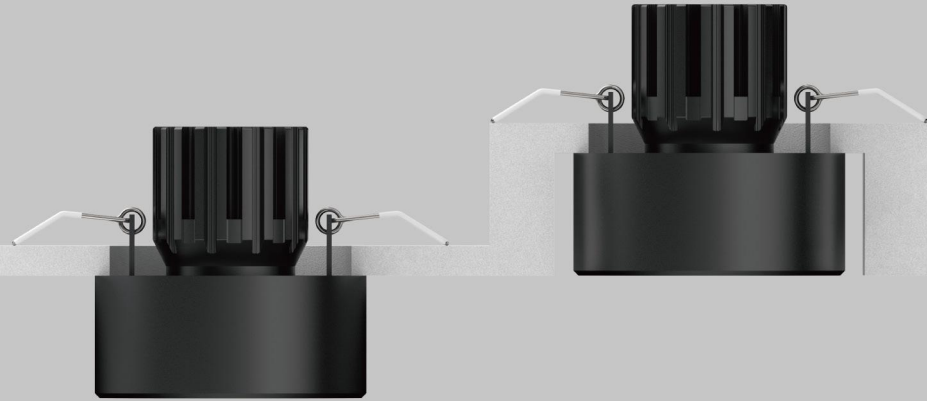

Basic Information

Model	GK75-R15QS
Mounting	Semi-recessed
Power	Max. 15W
CCT	3000K <input type="radio"/> 3500K <input type="radio"/> 4000K <input type="radio"/>
Beam Angle	<input type="checkbox"/> 15° <input type="checkbox"/> 25° <input type="checkbox"/> 35°
UGR	< 9
IP Rating	IP20
Lumens	65lm/W 90lm/W
CRI	97Ra /90Ra

Driver Voltage	AC100-120V AC220-240V
Driver Options	ON/OFF DIM TRIAC/ PHASE-CUT DIM 0/1-10V

GK75-R15QS

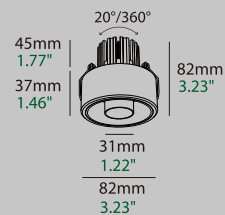

GEEK Semi-recessed



GEEK Twins

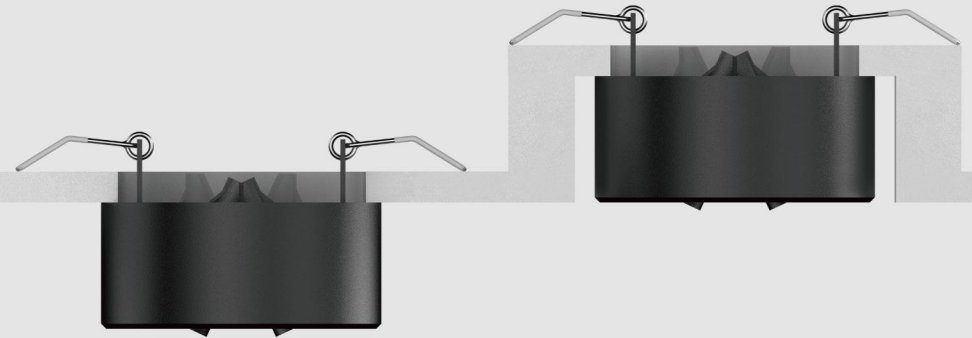

Basic Information

Model	GK75-R18QS
Mounting	Semi-recessed
Power	Max. 8W
CCT	3000K <input type="radio"/> 3500K <input type="radio"/> 4000K <input type="radio"/>
Beam Angle	<input type="checkbox"/> 15° <input type="checkbox"/> 25°
UGR	< 13
IP Rating	IP20
Lumens	40lm/W
CRI	90Ra

Driver Voltage	AC100-120V AC220-240V
Driver Options	ON/OFF DIM TRIAC/ PHASE-CUT DIM 0/1-10V

GK75-R18QS

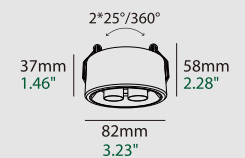

Geek Family



GK75-R07Q

GK75-R07QT

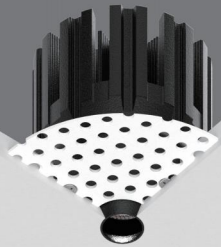

9mm



GK75-R07QT

78.00mm
3.07"



58.00mm
2.28"

9mm
0.35"

Basic Information

Model	GK75-R07QT
Mounting	Recessed
Trim Finishing Color	White
Reflector Color	Black
Material	Pure aluminum 6063
Cutout Size	∅ 55mm
Light Direction	/
IP Rating	IP20
Power	Max. 10W
Input Voltage	DC36V
Input Current	Max. 250mA

Optical Parameters

Light Source	LED COB
Lumens	30lm/W
CRI	97Ra
CCT	2700K ● 3000K ● 3500K ● 4000K ○
Beam Angle	▲ 45°
UGR	< 6
LED Lifespan	50000hrs

Driver Voltage	AC100-120V AC220-240V
Driver Options	ON/OFF DIM TRIAC/ PHASE-CUT DIM 0/1-10V DIM DALI

Suitable for Low Ceiling →

 75mm



GK75-R00Q



GK75-R00QS

GK75-R00QT

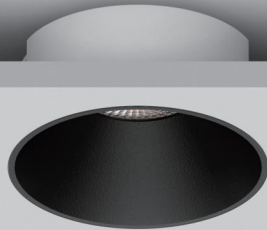

With Trim

Trimless

White

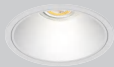

Black

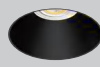
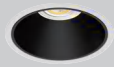

GK75-R00QS

GK75-R00QT

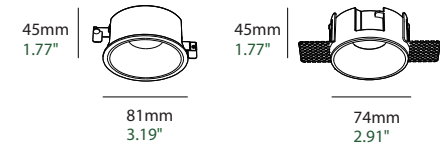

Basic Information

Model	GK75-R00QS / GK75-R00QT
Embedded Parts	With Trim / Trimless
Mounting	Recessed
Trim Finishing Color	White
Reflector Color	White/Black
Material	Aluminum
Cutout Size	∅ 75mm
IP Rating	IP20
Power	Max.8W
Input Voltage	DC36V
Input Current	Max. 200mA

Optical Parameters

Light Source	LED COB
Lumens	65lm/W 90lm/W
CRI	97Ra / 90Ra
CCT	3000K ● 3500K ● 4000K ○
CCT Changeable	2700K 6000K
Beam Angle	25° 50°
UGR	< 16
LED Lifespan	50000hrs

Driver Voltage	AC100-120V AC220-240V
Driver Options	ON/OFF DIM TRIAC/ PHASE-CUT DIM 0/1-10V DIM DALI

GK75-S00Q



GK75-S00QS

GK75-S00QT

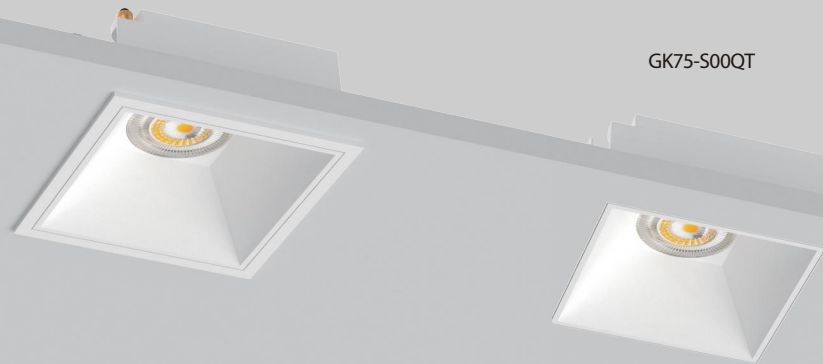
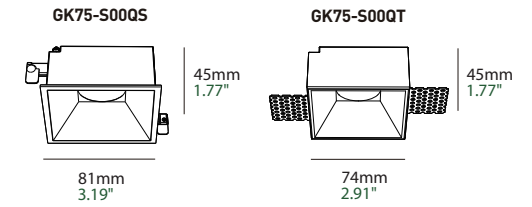

With Trim

Trimless

White



Black



Golden



Basic Information

Model	GK75-S00QS / GK75-S00QT
Embedded Parts	With Trim / Trimless
Mounting	Recessed
Trim Finishing Color	White
Reflector Color	White/Black/Golden
Material	Aluminum
Cutout Size	75*75mm
Light Direction	Fixed
IP Rating	IP20
Power	Max.8W
Input Voltage	DC36V
Input Current	Max. 200mA

Optical Parameters

Light Source	LED COB
Lumens	65lm/W 90lm/W
CRI	97Ra / 90Ra
CCT	3000K ● 3500K ● 4000K ○
CCT Changeable	2700K 6000K
Beam Angle	25° 50°
UGR	<16
LED Lifespan	50000hrs

Driver Voltage	AC100-120V AC220-240V
Driver Options	ON/OFF DIM TRIAC/ PHASE-CUT DIM 0/1-10V DIM DALI

GEEK Square



GEEK Square



GK75-S01QS

GK75-S01QT

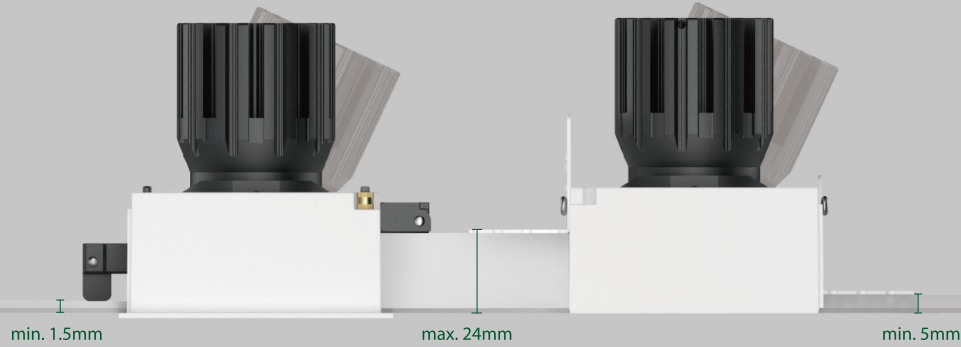

With Trim

Trimless

White



Black

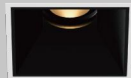

Golden



GK75-S01QS

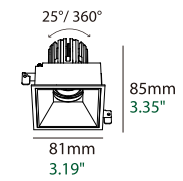

GK75-S01QT

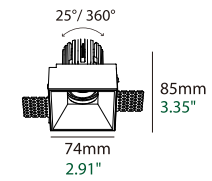

Basic Information

Model	GK75-S01QS/S01QT
Embedded Parts	With Trim/Trimless
Mounting	Recessed
Trim Finishing Color	White/Black
Reflector Color	White/Black/Golden
Material	Cold Forged Pure Alu. (Heat Sink)/Die-casting Alu.
Cutout Size	75*75mm
Light Direction	25° 360°
IP Rating	IP20
Power	Max. 15W
Input Voltage	DC36V
Input Current	Max. 350mA

Optical Parameters

Light Source	LED COB
Lumens	65lm/W 90lm/W
CRI	97Ra / 90Ra
CCT	3000K 3500K 4000K
CCT Changeable	2700K 6000K 1800K 3000K
Beam Angle	15° 25° 35° 50°
Shielding Angle	50°
UGR	< 13
LED Lifespan	50000hrs

Driver Voltage	AC100-120V AC220-240V
Driver Options	ON/OFF DIM TRIAC/ PHASE-CUT DIM 0/1-10V DIM DALI

GEEK Square Double/Four Heads

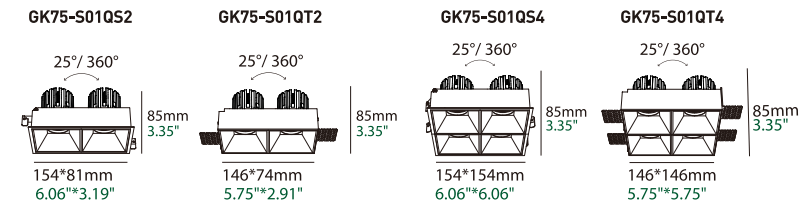

GK75-S01QS2/4

GK75-S01QT2/4

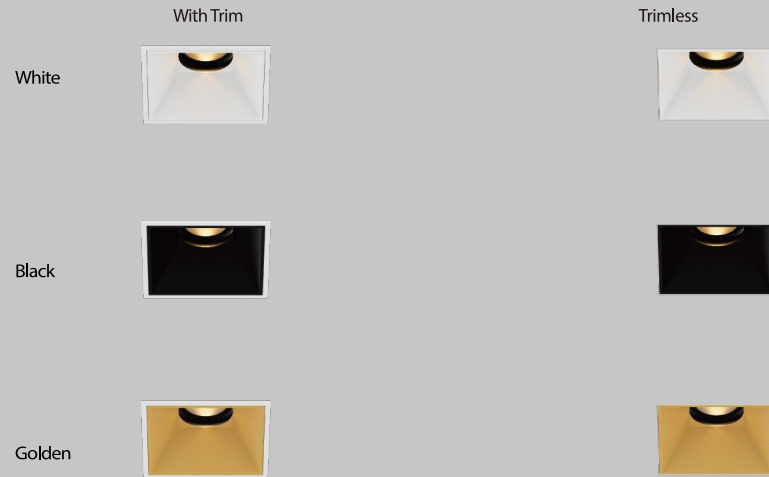
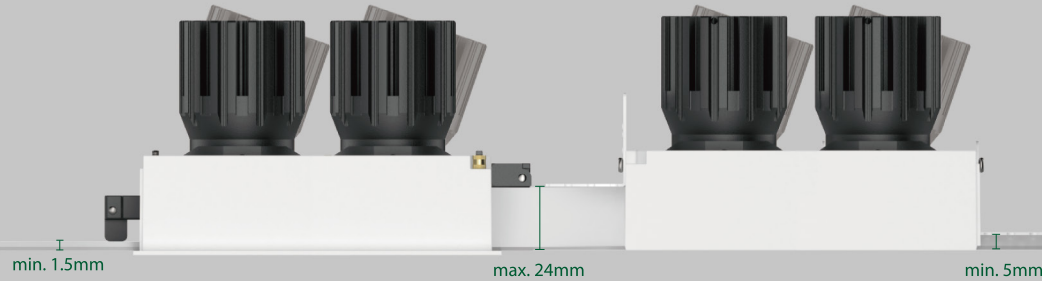

Basic Information

Model	GK75-S01QS2/4 GK75-S01QT2/4
Embedded Parts	With Trim/Trimless
Mounting	Recessed
Trim Finishing Color	White/Black
Reflector Color	White/Black/Golden
Material	Cold Forged Pure Alu. (Heat Sink)/Die-casting Alu.
Cutout Size	L148*75mm/L148*148mm
Light Direction	25° 360°
IP Rating	IP20
Power	Max. 2*15W/4*15W
Input Voltage	DC36V
Input Current	Max. 2*350mA/4*350mA

Optical Parameters

Light Source	LED COB
Lumens	65lm/W 90lm/W
CRI	97Ra / 90Ra
CCT	3000K ● 3500K ● 4000K ○
CCT Changeable	2700K — 6000K 1800K — 3000K
Beam Angle	15° 25° 35° 50°
Shielding Angle	50°
UGR	< 13
LED Lifespan	50000hrs

Driver Voltage AC100-120V AC220-240V

Driver Options ON/OFF DIM TRIAC/ PHASE-CUT DIM 0/1-10V DIM DALI

GEEK Square IP44

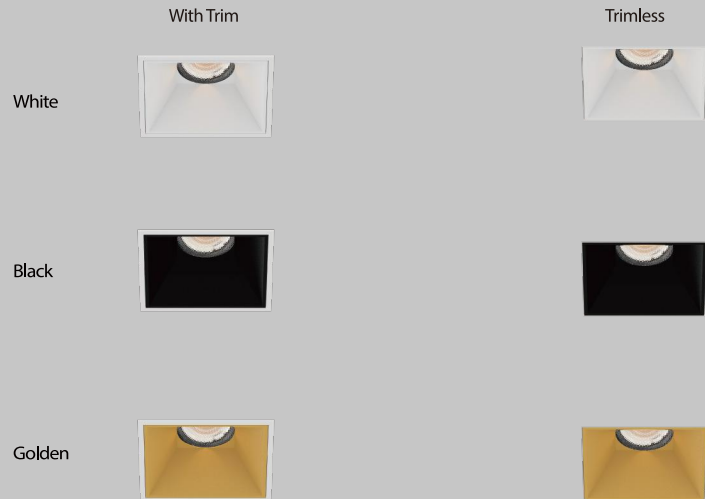
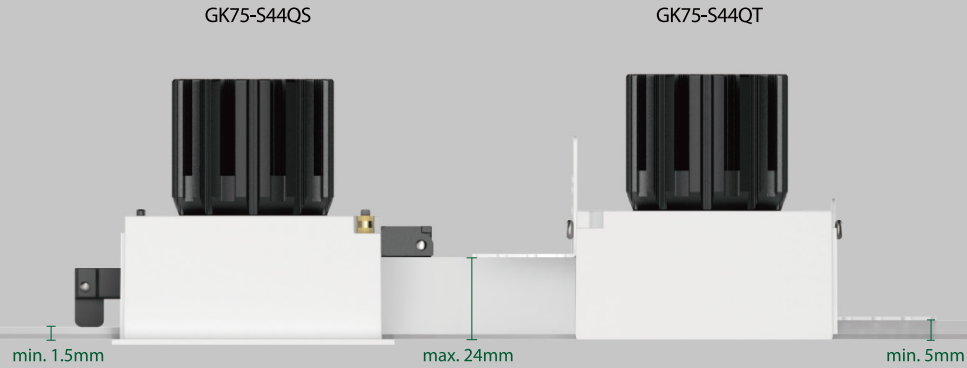

GK75-S44QS

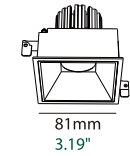

GK75-S44QT

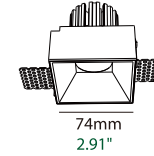

Basic Information

Model	GK75-S44QS/S44QT
Embedded Parts	With Trim/Trimless
Mounting	Recessed
Trim Finishing Color	White/Black
Reflector Color	White/Black/Golden
Material	Cold Forged Pure Alu. (Heat Sink)/Die-casting Alu.
Cutout Size	75*75mm
Light Direction	Fixed
IP Rating	IP44
Power	Max. 15W
Input Voltage	DC36V
Input Current	Max. 350mA

Optical Parameters

Light Source	LED COB
Lumens	65lm/W 90lm/W
CRI	97Ra / 90Ra
CCT	3000K ● 3500K ● 4000K ○
CCT Changeable	2700K — 6000K 1800K — 3000K
Beam Angle	15° 25° 35° 50°
Shielding Angle	35°
UGR	< 16
LED Lifespan	50000hrs

Driver Voltage	AC100-120V AC220-240V
Driver Options	ON/OFF DIM TRIAC/ PHASE-CUT DIM 0/1-10V DIM DALI

GEEK Square IP44 Double/Four Heads



GK75-S44QS2/4

GK75-S44QT2/4

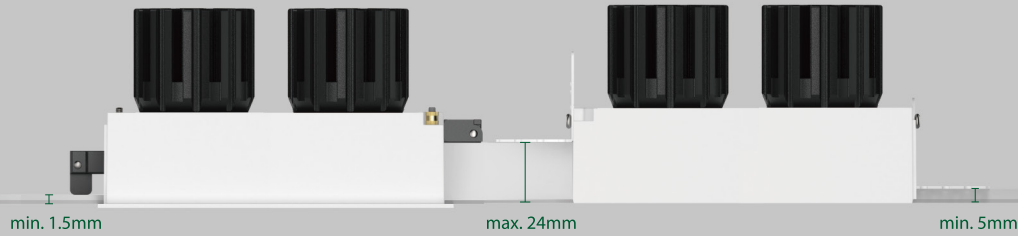

With Trim

Trimless

White



Black



Golden

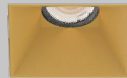

GK75-S44QS2

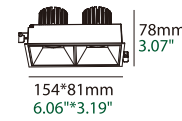

GK75-S44QT2

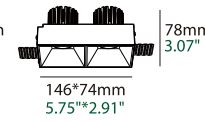

GK75-S44QS4

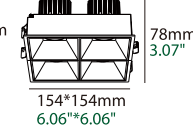

GK75-S44QT4

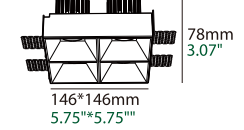

Basic Information

Model	GK75-S44QS2/4 GK75-S44QT2/4
Embedded Parts	With Trim/Trimless
Mounting	Recessed
Trim Finishing Color	White/Black
Reflector Color	White/Black/Golden
Material	Cold Forged Pure Alu. (Heat Sink)/Die-casting Alu.
Cutout Size	L148*75mm / L148*148mm
Light Direction	Fixed
IP Rating	IP44
Power	Max. 2*15W/4*15W
Input Voltage	DC36V
Input Current	Max. 2*350mA/4*350mA

Optical Parameters

Light Source	LED COB
Lumens	65lm/W 90lm/W
CRI	97Ra / 90Ra
CCT	3000K ● 3500K ● 4000K ○
CCT Changeable	2700K — 6000K 1800K — 3000K
Beam Angle	15° 25° 35° 50°
Shielding Angle	35°
UGR	< 16
LED Lifespan	50000hrs

Driver Voltage AC100-120V AC220-240V

Driver Options ON/OFF DIM TRIAC/ PHASE-CUT DIM 0/1-10V DIM DALI

GEEK Square IP65

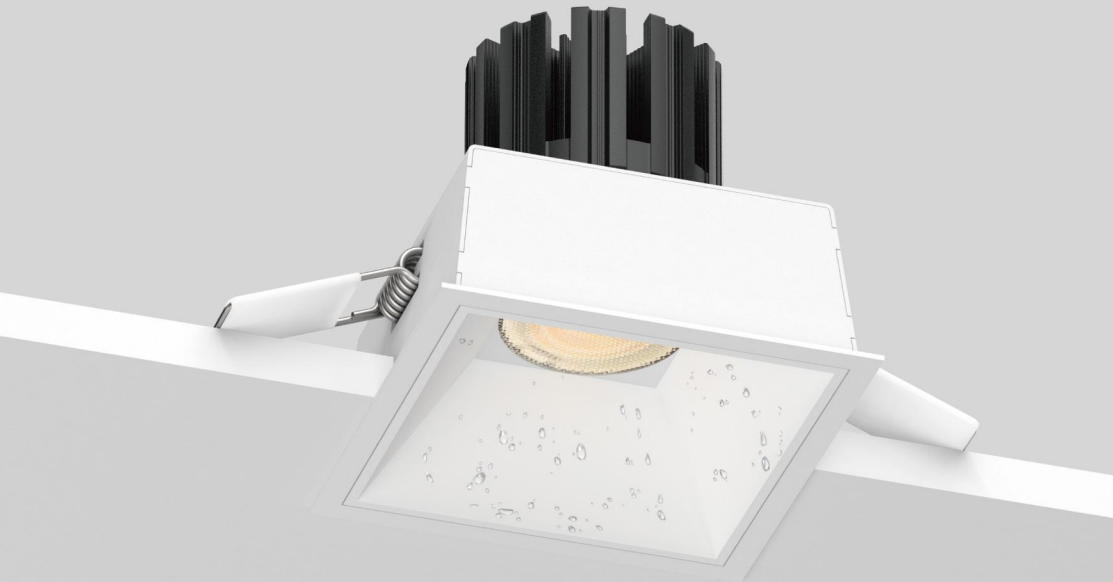

With Trim-White

With Trim-Black

White



Black



Golden



GK75-S65QS

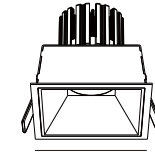

78mm
3.07"

82mm
3.23"

Basic Information

Model	GK75-S65QS
Embedded Parts	With Trim
Mounting	Recessed
Trim Finishing Color	White/Black
Reflector Color	White/Black/Golden
Material	Cold Forged Pure Alu. (Heat Sink)/Die-casting Alu.
Cutout Size	75*75mm
Light Direction	Fixed
IP Rating	IP65
Power	Max. 15W
Input Voltage	DC36V
Input Current	Max. 350mA

Optical Parameters

Light Source	LED COB
Lumens	65lm/W 90lm/W
CRI	97Ra / 90Ra
CCT	3000K ● 3500K ● 4000K ○
CCT Changeable	2700K — 6000K 1800K — 3000K
Beam Angle	15° 25° 35° 50°
Shielding Angle	35°
UGR	< 16
LED Lifespan	50000hrs

Driver Voltage AC100-120V AC220-240V

Driver Options ON/OFF DIM TRIAC/ PHASE-CUT DIM 0/1-10V DIM DALI

GEEK Surface

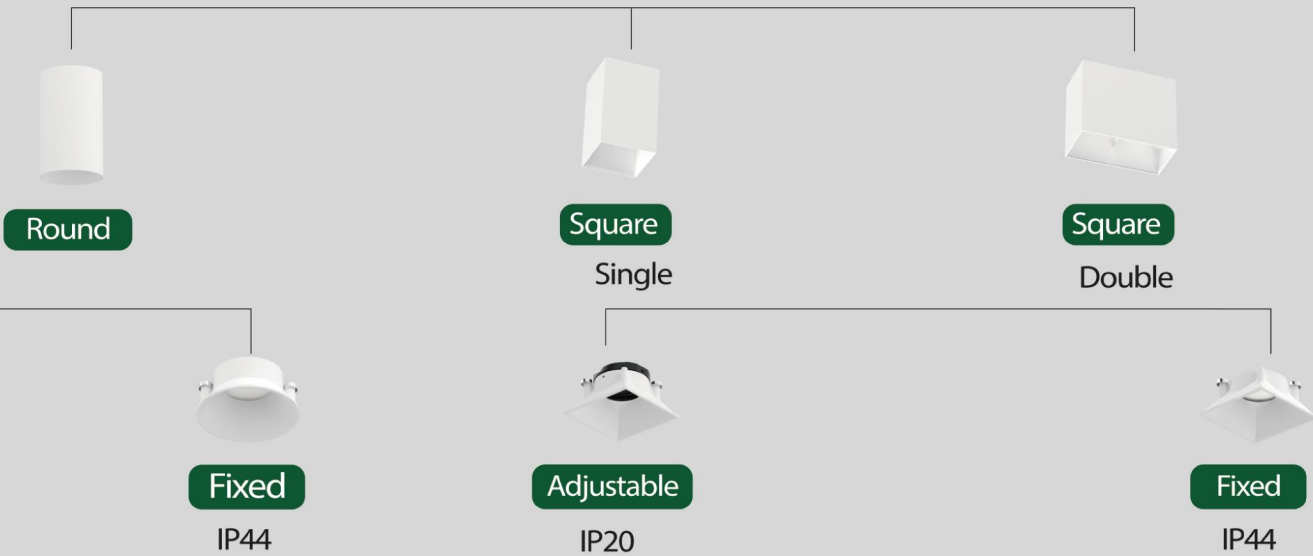

R01M R44M



R08M R05M R03M



S01M S44M S02M S46M

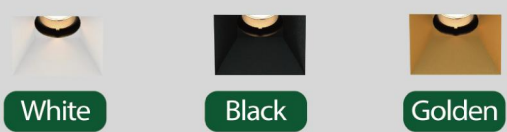

GEEK Surface Round

GK75-R01M



GK75-R01M

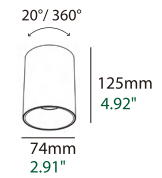

Basic Information

Model	GK75-R01M
Mounting	Surface mounted
Finishing Color	White/Black
Reflector Color	White/Black/Golden
Material	Cold Forged Pure Alu. (Heat Sink)/Die-casting Alu.
Light Direction	20° 360°
IP Rating	IP20
Power	Max. 10W
Input Voltage	DC36V
Input Current	Max. 250mA

Optical Parameters

Light Source	LED COB
Lumens	65lm/W 90lm/W
CRI	97Ra / 90Ra
CCT	3000K 3500K 4000K
CCT Changeable	2700K 6000K 1800K 3000K
Beam Angle	15° 25° 35° 50°
Shielding Angle	50°
UGR	< 13
LED Lifespan	50000hrs

Driver Voltage	AC100-120V AC220-240V
Driver Options	ON/OFF DIM TRIAC/ PHASE-CUT DIM 0/1-10V DIM DALI

GEEK Surface Round IP44

GK75-R44M



White

Black

Golden

White



Black



GK75-R44M

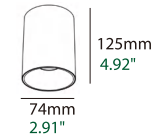

Basic Information

Model	GK75-R44M
Mounting	Surface mounted
Finishing Color	White/Black
Reflector Color	White/Black/Golden
Material	Cold Forged Pure Alu. (Heat Sink)/Die-casting Alu.
Light Direction	Fixed
IP Rating	IP44
Power	Max. 10W
Input Voltage	DC36V
Input Current	Max. 250mA

Optical Parameters

Light Source	LED COB
Lumens	65lm/W 90lm/W
CRI	97Ra / 90Ra
CCT	3000K ● 3500K ● 4000K ○
CCT Changeable	2700K — 6000K 1800K — 3000K
Beam Angle	15° 25° 35° 50°
Shielding Angle	35°
UGR	< 16
LED Lifespan	50000hrs

Driver Voltage	AC100-120V AC220-240V
Driver Options	ON/OFF DIM TRIAC/ PHASE-CUT DIM 0/1-10V DIM DALI

GEEK Surface Stretchable

GK75-R03M



White

Black

Golden

White



Black



GK75-R03M

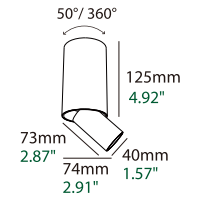

Basic Information

Model	GK75-R03M
Mounting	Surface mounted
Finishing Color	White/Black
Reflector Color	White/Black/Golden
Material	Pure Alu. (Heat Sink)/Die-casting Alu.
Light Direction	50° 360°
IP Rating	IP20
Power	Max. 10W
Input Voltage	DC36V
Input Current	Max. 250mA

Optical Parameters

Light Source	LED COB
Lumens	65lm/W 90lm/W
CRI	97Ra / 90Ra
CCT	3000K 3500K 4000K
CCT Changeable	2700K 6000K 1800K 3000K
Beam Angle	15° 25°
Shielding Angle	45°
UGR	< 13
LED Lifespan	50000hrs

Driver Voltage	AC100-120V AC220-240V
Driver Options	ON/OFF DIM TRIAC/ PHASE-CUT DIM 0/1-10V DIM DALI

GEEK Surface Snout

Geek Family

GK75-R05M

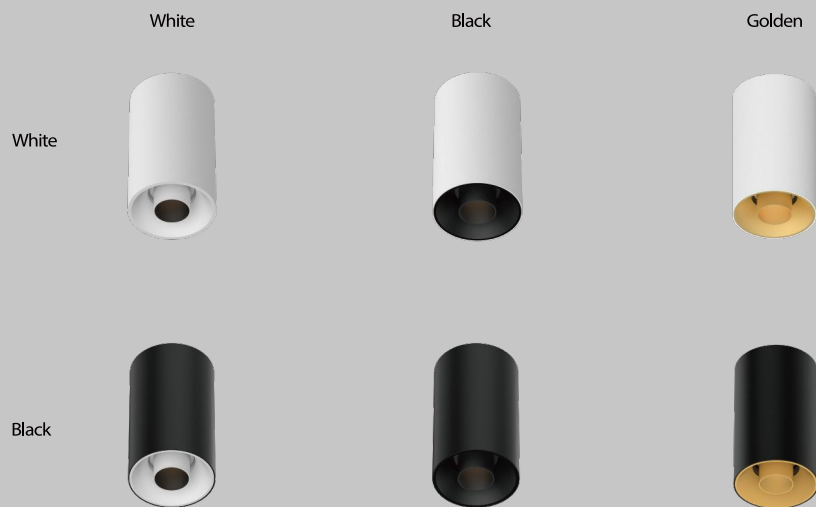

GK75-R05M

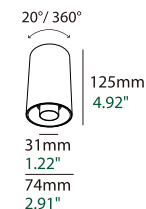

Basic Information

Model	GK75-R05M
Mounting	Surface mounted
Finishing Color	White/Black
Reflector Color	White/Black/Golden
Material	Cold Forged Pure Alu. (Heat Sink)/Die-casting Alu.
Light Direction	20° 360°
IP Rating	IP20
Power	Max. 10W
Input Voltage	DC36V
Input Current	Max. 250mA

Optical Parameters

Light Source	LED COB
Lumens	65lm/W 90lm/W
CRI	97Ra / 90Ra
CCT	3000K 3500K 4000K
CCT Changeable	2700K 6000K 1800K 3000K
Beam Angle	15° 25° 35°
Shielding Angle	67°
UGR	<9
LED Lifespan	50000hrs

Driver Voltage	AC100-120V AC220-240V
Driver Options	ON/OFF DIM TRIAC/ PHASE-CUT DIM 0/1-10V DIM DALI

GEEK Surface Twins

GK75-R08M



White

Black

Golden

White



Black



GK75-R08M

2*25°/360°

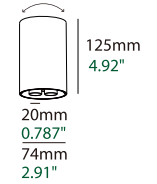

Basic Information

Model	GK75-R08M
Mounting	Surface mounted
Finishing Color	White/Black
Reflector Color	White/Black/Golden
Material	Pure Alu. (Heat Sink)/Die-casting Alu.
Light Direction	2*25° 360°
IP Rating	IP20
Power	Max. 8W
Input Voltage	DC36V
Input Current	Max. 180mA

Optical Parameters

Light Source	LED COB
Lumens	40lm/W
CRI	90Ra
CCT	3000K ● 3500K ● 4000K ○
Beam Angle	15° 25°
UGR	< 13
LED Lifespan	50000hrs

Driver Voltage	AC100-120V AC220-240V
Driver Options	ON/OFF DIM TRIAC/ PHASE-CUT DIM 0/1-10V DIM DALI

GEEK Surface Round IP65

Geek Family

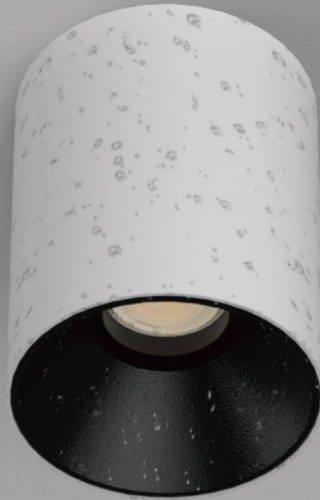

White

Black

Golden

White



Black



GK75-R65M



90mm
3.54"

74mm
2.91"

Basic Information

Model	GK75-R65M
Mounting	Surface mounted
Finishing Color	White/Black
Reflector Color	White/Black/Golden
Material	Pure Alu. (Heat Sink)/Die-casting Alu.
Light Direction	Fixed
IP Rating	IP65
Power	Max. 10W
Input Voltage	DC36V
Input Current	Max. 250mA

Optical Parameters

Light Source	LED COB
Lumens	65lm/W 90lm/W
CRI	97Ra / 90Ra
CCT	3000K ● 3500K ● 4000K ○
CCT Changeable	2700K — 6000K 1800K — 3000K
Beam Angle	50°
Shielding Angle	50°
UGR	< 13
LED Lifespan	50000hrs

Driver Voltage AC100-120V AC220-240V

Driver Options ON/OFF DIM TRIAC/ PHASE-CUT DIM 0/1-10V DIM DALI

GEEK Surface Square



GK75-S01M

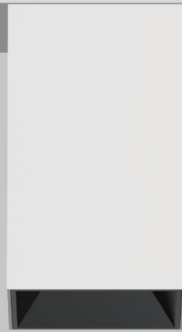

White

Black

Golden

White

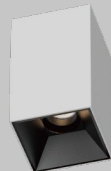

Black



GK75-S01M

20° / 360°

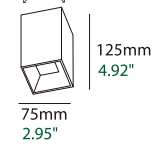

Basic Information

Model	GK75-S01M
Mounting	Surface mounted
Finishing Color	White/Black
Reflector Color	White/Black/Golden
Material	Cold Forged Pure Alu. (Heat Sink)/Die-casting Alu.
Light Direction	20° 360°
IP Rating	IP20
Power	Max. 10W
Input Voltage	DC36V
Input Current	Max. 250mA

Optical Parameters

Light Source	LED COB
Lumens	65lm/W 90lm/W
CRI	97Ra / 90Ra
CCT	3000K ● 3500K ● 4000K ○
CCT Changeable	2700K — 6000K 1800K — 3000K
Beam Angle	15° 25° 35° 50°
Shielding Angle	50°
UGR	< 13
LED Lifespan	50000hrs

Driver Voltage	AC100-120V AC220-240V
Driver Options	ON/OFF DIM TRIAC/ PHASE-CUT DIM 0/1-10V DIM DALI

GEEK Surface Square IP44

GK75-S44M

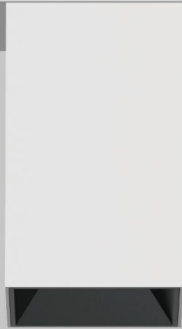

White

Black

Golden

White



Black



GK75-S44M

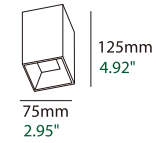

Basic Information

Model	GK75-S44M
Mounting	Surface mounted
Finishing Color	White/Black
Reflector Color	White/Black/Golden
Material	Cold Forged Pure Alu. (Heat Sink)/Die-casting Alu.
Light Direction	Fixed
IP Rating	IP44
Power	Max. 10W
Input Voltage	DC36V
Input Current	Max. 250mA

Optical Parameters

Light Source	LED COB
Lumens	65lm/W 90lm/W
CRI	97Ra / 90Ra
CCT	3000K ● 3500K ● 4000K ○
CCT Changeable	2700K — 6000K 1800K — 3000K
Beam Angle	15° 25° 35° 50°
Shielding Angle	35°
UGR	< 16
LED Lifespan	50000hrs

Driver Voltage	AC100-120V AC220-240V
Driver Options	ON/OFF DIM TRIAC/ PHASE-CUT DIM 0/1-10V DIM DALI

GEEK Surface Square Double

GK75-S02M

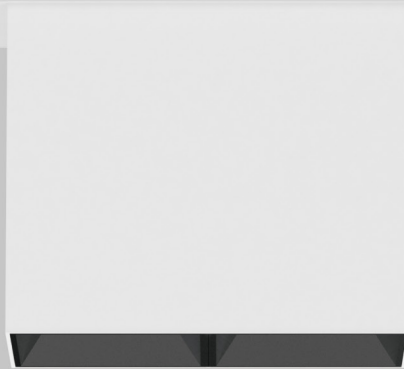

White

Black

Golden

White

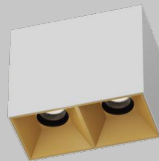

Black

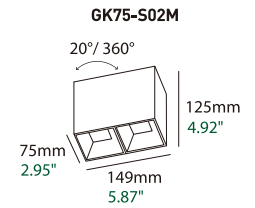
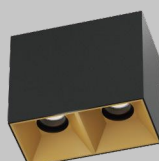

Basic Information

Model	GK75-S02M
Mounting	Surface mounted
Finishing Color	White/Black
Reflector Color	White/Black/Golden
Material	Cold Forged Pure Alu. (Heat Sink)/Die-casting Alu.
Light Direction	20° 360°
IP Rating	IP20
Power	Max. 2*10W
Input Voltage	DC36V
Input Current	Max. 2*250mA

Optical Parameters

Light Source	LED COB
Lumens	65lm/W 90lm/W
CRI	97Ra / 90Ra
CCT	3000K 3500K 4000K
CCT Changeable	2700K 6000K 1800K 3000K
Beam Angle	15° 25° 35° 50°
Shielding Angle	50°
UGR	< 13
LED Lifespan	50000hrs

Driver Voltage	AC100-120V AC220-240V
Driver Options	ON/OFF DIM TRIAC/ PHASE-CUT DIM 0/1-10V DIM DALI

GEEK Surface Square IP44 Double

GK75-S46M

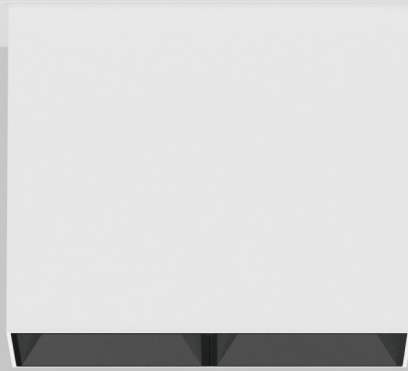

White

Black

Golden

White

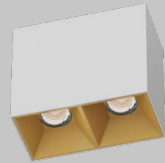

Black

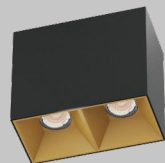

GK75-S46M

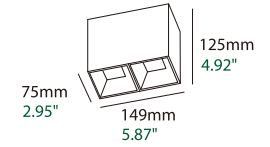

Basic Information

Model	GK75-S46M
Mounting	Surface mounted
Finishing Color	White/Black
Reflector Color	White/Black/Golden
Material	Cold Forged Pure Alu. (Heat Sink)/Die-casting Alu.
Light Direction	Fixed
IP Rating	IP44
Power	Max. 2*10W
Input Voltage	DC36V
Input Current	Max. 2*250mA

Optical Parameters

Light Source	LED COB
Lumens	65lm/W 90lm/W
CRI	97Ra / 90Ra
CCT	3000K ● 3500K ● 4000K ○
CCT Changeable	2700K — 6000K 1800K — 3000K
Beam Angle	15° 25° 35° 50°
Shielding Angle	35°
UGR	< 16
LED Lifespan	50000hrs

Driver Voltage AC100-120V AC220-240V

Driver Options ON/OFF DIM TRIAC/ PHASE-CUT DIM 0/1-10V DIM DALI

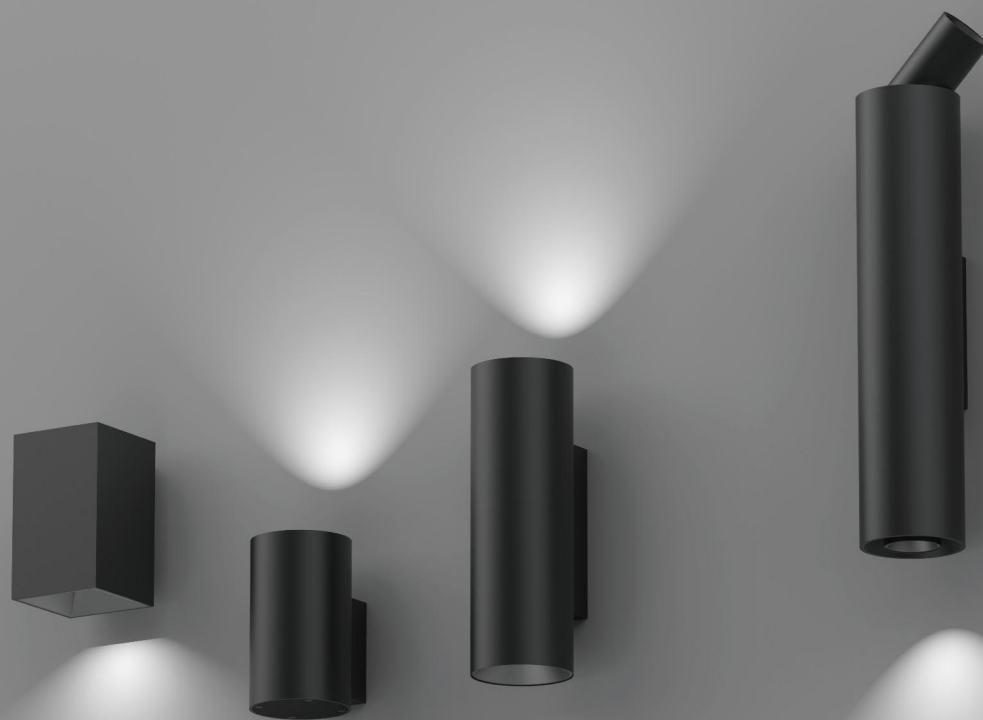

GEEK Wall Lamp

GEEK Wall Lamp Round H125



GKW1-R01



GKW1-R03



GKW1-R05

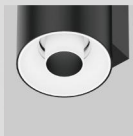

GKW1-R08

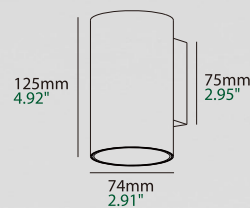
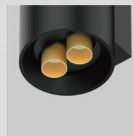

GKW1-R01 | 8W | CRI97 65lm/W | 3000K ● 3500K ● 4000K ○ | 25° | Bridgelux 50000hrs

Finishing Color _____ White/Black

Reflector Color _____ White/Black/Golden

Material _____ Cold Forged Pure Alu. (Heat Sink)/Die-casting Alu.

Light Direction _____ 20°

IP Rating _____ IP20



GKW1-R03 | 8W | CRI97 65lm/W | 3000K ● 3500K ● 4000K ○ | 25° | Bridgelux 50000hrs

Finishing Color _____ White/Black

Reflector Color _____ White/Black/Golden

Material _____ Pure Alu. (Heat Sink)/Die-casting Alu.

Light Direction _____ 50°

IP Rating _____ IP20

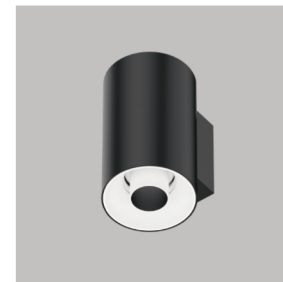

GKW1-R05 | 8W | CRI97 65lm/W | 3000K ● 3500K ● 4000K ○ | 35° | Bridgelux 50000hrs

Finishing Color _____ White/Black

Reflector Color _____ White/Black/Golden

Material _____ Cold Forged Pure Alu. (Heat Sink)/Die-casting Alu.

Light Direction _____ 20°

IP Rating _____ IP20



GKW1-R08 | 8W | CRI90 40lm/W | 3000K ● 3500K ● 4000K ○ | 25° | 50000hrs

Finishing Color _____ White/Black

Reflector Color _____ White/Black/Golden

Material _____ Pure Alu. (Heat Sink)/Die-casting Alu.

Light Direction _____ 2*25°

IP Rating _____ IP20

Driver Voltage AC100-120V AC220-240V

Driver Options ON/OFF DIM TRIAC/ PHASE-CUT DIM 0/1-10V DIM DALI

GEEK Wall Lamp Round H325 Double

Geek Family



GKW3-R0101



GKW3-R0303

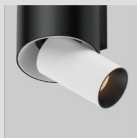

GKW3-R0505



GKW3-R0808

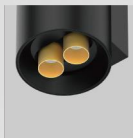

325mm
12.8"

125mm
4.92"



74mm
2.91"



GKW3-R0101	15W	CR197 65lm/W	3000K ● 3500K ● 4000K ○	25° 50°	Bridgelux 50000hrs
Finishing Color	White/Black				
Reflector Color	White/Black/Golden				
Material	Cold Forged Pure Alu. (Heat Sink)/Die-casting Alu.				
Light Direction	20°				
IP Rating	IP20				



GKW3-R0303	15W	CR197 65lm/W	3000K ● 3500K ● 4000K ○	25°	Bridgelux 50000hrs
Finishing Color	White/Black				
Reflector Color	White/Black/Golden				
Material	Pure Alu. (Heat Sink)/Die-casting Alu.				
Light Direction	50°				
IP Rating	IP20				



GKW3-R0505	15W	CR197 65lm/W	3000K ● 3500K ● 4000K ○	35°	Bridgelux 50000hrs
Finishing Color	White/Black				
Reflector Color	White/Black/Golden				
Material	Cold Forged Pure Alu. (Heat Sink)/Die-casting Alu.				
Light Direction	20°				
IP Rating	IP20				



GKW3-R0808	2*8W	CR190 40lm/W	3000K ● 3500K ● 4000K ○	25°	50000hrs
Finishing Color	White/Black				
Reflector Color	White/Black/Golden				
Material	Pure Alu. (Heat Sink)/Die-casting Alu.				
Light Direction	2*25°				
IP Rating	IP20				

Driver Voltage	AC100-120V AC220-240V
Driver Options	ON/OFF DIM TRIAC/ PHASE-CUT DIM 0/1-10V DIM DALI

GEEK Wall Lamp Square H125/H325

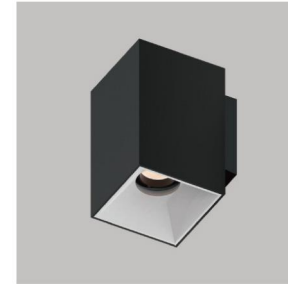
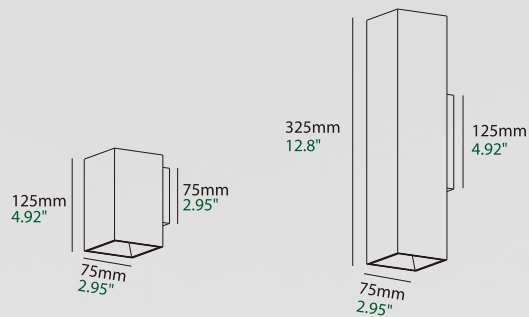

GKW1-S01 | 8W | CRI97 | 65lm/W | 3000K ● 3500K ● 4000K ○ | 25° | 50° | Bridgelux | 50000hrs

Finishing Color	White/Black
Reflector Color	White/Black/Golden
Material	Cold Forged Pure Alu. (Heat Sink)/Die-casting Alu.
Light Direction	20°
IP Rating	IP20



GKW3-S0101 | 15W | CRI97 | 65lm/W | 3000K ● 3500K ● 4000K ○ | 25° | 50° | Bridgelux | 50000hrs

Finishing Color	White/Black
Reflector Color	White/Black/Golden
Material	Cold Forged Pure Alu. (Heat Sink)/Die-casting Alu.
Light Direction	20°
IP Rating	IP20

Driver Voltage	AC100-120V AC220-240V
Driver Options	ON/OFF DIM TRIAC/ PHASE-CUT DIM 0/1-10V DIM DALI

GEEK Wall Lamp IP65

Geek Family

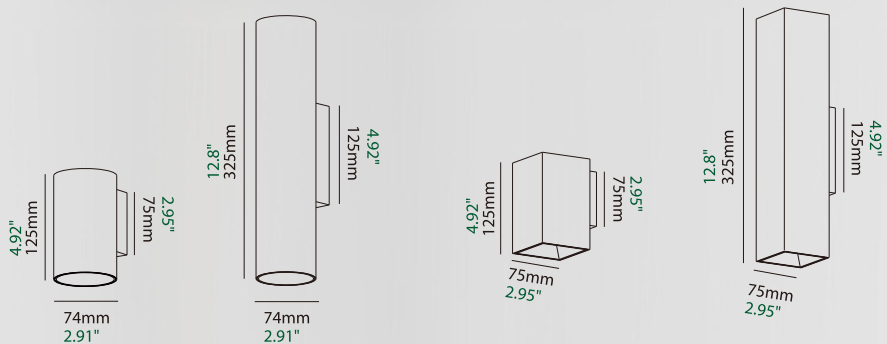

GKW1-R65	8W	CR197 65lm/W	3000K ● 3500K ● 4000K ○	50°	Bridgelux 50000hrs
Finishing Color	White/Black				
Reflector Color	White/Black/Golden				
Material	Cold Forged Pure Alu. (Heat Sink)/Die-casting Alu.				
Light Direction	Fixed				
IP Rating	IP65				



GKW3-R6565	15W	CR197 65lm/W	3000K ● 3500K ● 4000K ○	50°	Bridgelux 50000hrs
Finishing Color	White/Black				
Reflector Color	White/Black/Golden				
Material	Cold Forged Pure Alu. (Heat Sink)/Die-casting Alu.				
Light Direction	Fixed				
IP Rating	IP65				

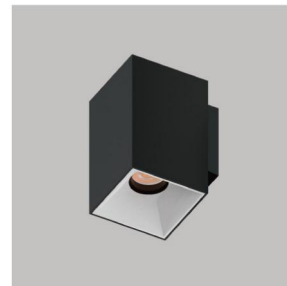

GKW1-S65	8W	CR197 65lm/W	3000K ● 3500K ● 4000K ○	50°	Bridgelux 50000hrs
Finishing Color	White/Black				
Reflector Color	White/Black/Golden				
Material	Cold Forged Pure Alu. (Heat Sink)/Die-casting Alu.				
Light Direction	Fixed				
IP Rating	IP65				

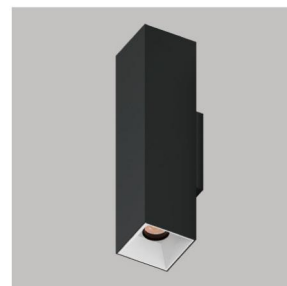

GKW3-S6565	15W	CR197 65lm/W	3000K ● 3500K ● 4000K ○	50°	Bridgelux 50000hrs
Finishing Color	White/Black				
Reflector Color	White/Black/Golden				
Material	Cold Forged Pure Alu. (Heat Sink)/Die-casting Alu.				
Light Direction	Fixed				
IP Rating	IP65				

Driver Voltage	AC100-120V AC220-240V
Driver Options	ON/OFF DIM TRIAC/ PHASE-CUT DIM 0/1-10V DIM DALI



GEEK Pendant Lamp

GEEK Pendant Lamp Round

Geek Family



GKD1-R01

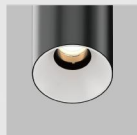

GKD1-R03



GKD1-R05

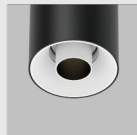

GKD1-R08

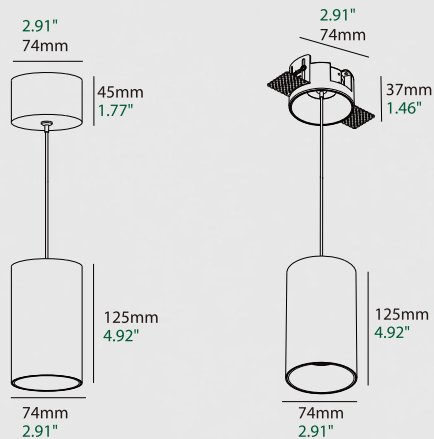
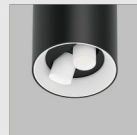

GKD1-R01	8W	CRI97 65lm/W	3000K ● 3500K ● 4000K ○	25° 50°	Bridgelux 50000hrs
Finishing Color	White/Black				
Reflector Color	White/Black/Golden				
Material	Cold Forged Pure Alu. (Heat Sink)/Die-casting Alu.				
Light Direction	20°				
IP Rating	IP20				



GKD1-R03	8W	CRI97 65lm/W	3000K ● 3500K ● 4000K ○	25° 50°	Bridgelux 50000hrs
Finishing Color	White/Black				
Reflector Color	White/Black/Golden				
Material	Pure Alu. (Heat Sink)/Die-casting Alu.				
Light Direction	50°				
IP Rating	IP20				



GKD1-R05	8W	CRI97 65lm/W	3000K ● 3500K ● 4000K ○	35° 50°	Bridgelux 50000hrs
Finishing Color	White/Black				
Reflector Color	White/Black/Golden				
Material	Cold Forged Pure Alu. (Heat Sink)/Die-casting Alu.				
Light Direction	20°				
IP Rating	IP20				



GKD1-R08	8W	CRI90 40lm/W	3000K ● 3500K ● 4000K ○	25° 50°	50000hrs
Finishing Color	White/Black				
Reflector Color	White/Black/Golden				
Material	Pure Alu. (Heat Sink)/Die-casting Alu.				
Light Direction	2*25°				
IP Rating	IP20				

Driver Voltage	AC100-120V AC220-240V
Driver Options	ON/OFF DIM TRIAC/ PHASE-CUT DIM 0/1-10V DIM DALI

GEEK Pendant Lamp Square



GKD1-S01	8W	CRI97	3000K	3500K	4000K	25°	Bridgelux	
		65lm/W				50°	50000hrs	
Finishing Color							White/Black	
Reflector Color							White/Black/Golden	
Material							Cold Forged Pure Alu. (Heat Sink)/Die-casting Alu.	
Light Direction							20°	
IP Rating							IP20	

Geek Family

GKD1-S01

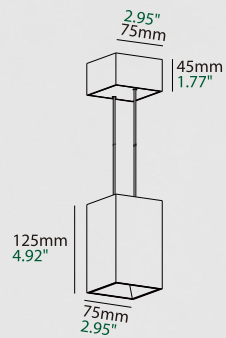
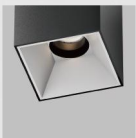

Driver Voltage	AC100-120V AC220-240V
Driver Options	ON/OFF DIM TRIAC/ PHASE-CUT DIM 0/1-10V DIM DALI

GENII Family

- Genii is born to be small but powerful.
- The family includes recessed, surface-mounted, waterproof, and polarized multiple choices.
- Dia 45mm, but cold-forged heat sink improves power to 10w.
- The meticulous surface treatment brings delicate touching, adding an elegant feeling to the space.



CRI97



45mm Mini Spot



High Lumen



Fully Metal-made

GENII Round



GN45-R01QS

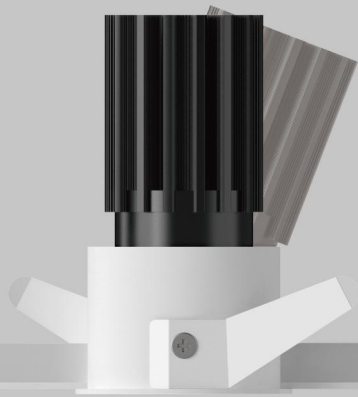

GN45-R01QT

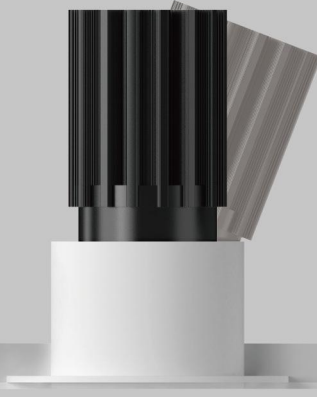

With Trim

Trimless

White



Black



Golden



Black Mirror



GN45-R01QS

20°/360°



50mm
1.97"

GN45-R01QT

20°/360°



68mm
2.68"

88mm
3.46"

88mm
3.46"

Basic Information

Model	GN45-R01QS/R01QT
Embedded Parts	With Trim/Trimless
Mounting	Recessed
Trim Finishing Color	White/Black
Reflector Color	White/Black/Golden/Black Mirror
Material	Cold Forged Pure Alu. (Heat Sink)/Die-casting Alu.
Cutout Size	∅ 45mm
Light Direction	⌵ 20° ⌳ 360°
IP Rating	IP20
Power	Max. 10W
Input Voltage	DC36V
Input Current	Max. 250mA

Optical Parameters

Light Source	LED COB
Lumens	65lm/W 90lm/W
CRI	97Ra / 90Ra
CCT	3000K ● 3500K ● 4000K ○
CCT Changeable	2700K — 6000K 1800K — 3000K
Beam Angle	⌵ 15° ⌵ 25° ⌵ 35° ⌵ 50°
Shielding Angle	52°
UGR	< 13
LED Lifespan	50000hrs

Driver Voltage	AC100-120V AC220-240V
Driver Options	ON/OFF DIM TRIAC/ PHASE-CUT DIM 0/1-10V DIM DALI

GENII Round IP44



GENII Family

GN45-R44QS

GN45-R44QT

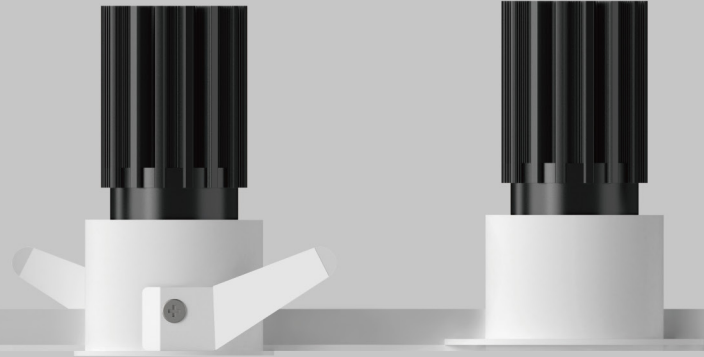

With Trim

Trimless

White

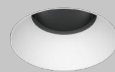

Black

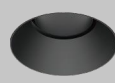

Golden

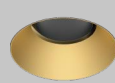

Black Mirror

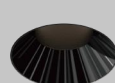
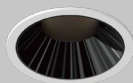

GN45-R44QS

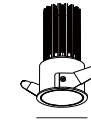

50mm
1.97"

85mm
3.35"

GN45-R44QT

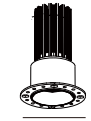

68mm
2.68"

85mm
3.35"

Basic Information

Model	GN45-R44QS/R44QT
Embedded Parts	With Trim/Trimless
Mounting	Recessed
Trim Finishing Color	White/Black
Reflector Color	White/Black/Golden/Black Mirror
Material	Cold Forged Pure Alu. (Heat Sink)/Die-casting Alu.
Cutout Size	45mm
Light Direction	Fixed
IP Rating	IP44
Power	Max. 10W
Input Voltage	DC36V
Input Current	Max. 250mA

Optical Parameters

Light Source	LED COB
Lumens	65lm/W 90lm/W
CRI	97Ra
CCT	3000K ● 3500K ● 4000K ○
CCT Changeable	2700K — 6000K 1800K — 3000K
Beam Angle	15° 25° 35° 50°
Shielding Angle	50°
UGR	< 13
LED Lifespan	50000hrs

Driver Voltage AC100-120V AC220-240V

Driver Options ON/OFF DIM TRIAC/ PHASE-CUT DIM 0/1-10V DIM DALI

GENII Round Polarized



GN45-R03QS

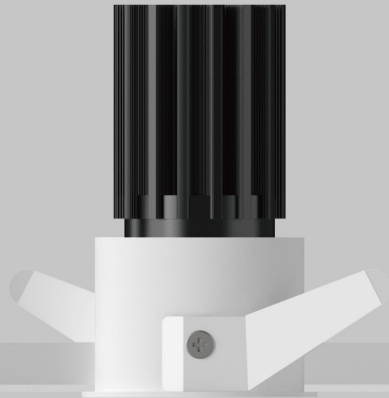

GN45-R03QT



Basic Information

Model	GN45-R03QS/R03QT
Mounting	Recessed
Power	Max. 10W
CCT	3000K ● 3500K ● 4000K ●
IP Rating	IP20
Lumens	30lm/W
CRI	97Ra

Driver Voltage	AC100-120V AC220-240V
Driver Options	ON/OFF DIM TRIAC/ PHASE-CUT DIM 0/1-10V

GN45-R03QS

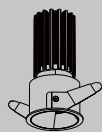

50mm
1.97"

83mm
3.27"

GN45-R03QT

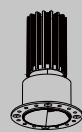

68mm
2.68"

83mm
3.27"

GENII Round Pinhole



GN45-R06QS



GN45-R06QT

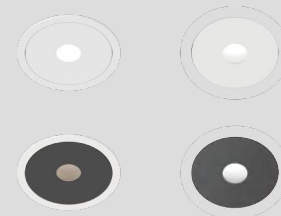

Basic Information

Model	GN45-R06QS/R06QT
Mounting	Recessed
Power	Max. 10W
CCT	3000K ● 3500K ● 4000K ●
Beam Angle	15°
UGR	< 5
IP Rating	IP20
Lumens	50lm/W
CRI	97Ra

Driver Voltage	AC100-120V AC220-240V
Driver Options	ON/OFF DIM TRIAC/ PHASE-CUT DIM 0/1-10V

GN45-R06QS

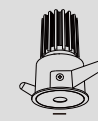

18mm
0.71"
50mm
1.97"

75mm
2.95"

GN45-R06QT

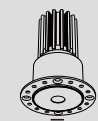

18mm
0.71"
68mm
2.68"

75mm
2.95"

GENII Cylinder

GENII Family



GN45-R02QS

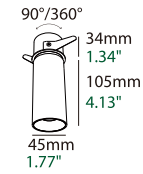

GN45-R02QT

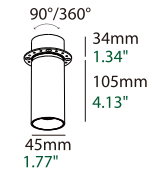

GN45-R02M

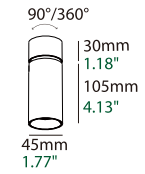

GN45-R01M

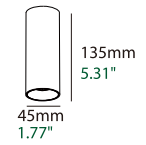

Basic Information

Model	GN45-R02QS/R02QT/R02M/R01M
Finishing Color	White/Black
Reflector Color	White/Black/Golden
Material	Pure Alu. (Heat Sink)/Die-casting Alu.
Cutout Size	∅ 45mm
IP Rating	IP20
Power	Max. 8W
Input Voltage	DC36V
Input Current	Max. 200mA

Optical Parameters

Light Source	LED COB
Lumens	65lm/W 90lm/W
CRI	97Ra / 90Ra
CCT	3000K ● 3500K ● 4000K ○
CCT Changeable	2700K — 6000K 1800K — 3000K
Beam Angle	▲ 15° ▲ 25° ▲ 35° ▲ 50°
Shielding Angle	52°
UGR	< 13
LED Lifespan	50000hrs

Driver Voltage AC100-120V AC220-240V

Driver Options ON/OFF DIM TRIAC/ PHASE-CUT DIM 0/1-10V DIM DALI

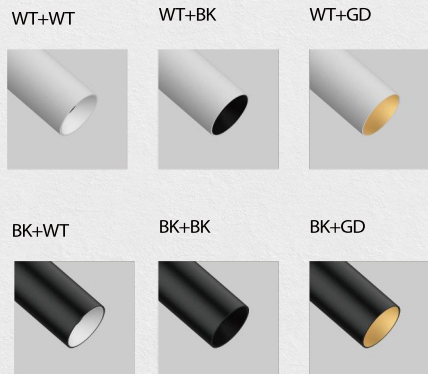



GENII Wall Lamp

GENII Wall Lamp H325

GENII Family



WT+WT



WT+BK

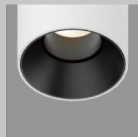

WT+GD



BK+WT



BK+BK



BK+GD

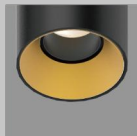

GNW3-R0101

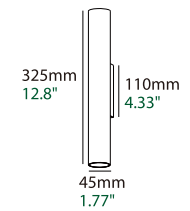

Basic Information

Model	GNW3-R0101
Mounting	Surface mounted
Finishing Color	White/Black
Reflector Color	White/Black/Golden
Material	Cold Forged Pure Alu. (Heat Sink)/Die-casting Alu.
IP Rating	IP20
Power	Max. 15W
Input Voltage	DC36V
Input Current	Max. 350mA

Optical Parameters

Light Source	LED COB
Lumens	65lm/W
CRI	97Ra
CCT	3000K ● 3500K ● 4000K ○
CCT Changeable	2700K — 6000K 1800K — 3000K
Beam Angle	▼ 25° ▲ 50°
LED Lifespan	50000hrs

Driver Voltage	AC100-120V AC220-240V
Driver Options	ON/OFF DIM TRIAC/ PHASE-CUT DIM 0/1-10V DIM DALI

GENII Pendant Lamp H325



WT+WT



WT+BK

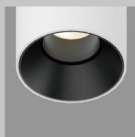

WT+GD



BK+WT



BK+BK



BK+GD

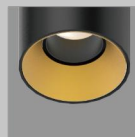

GND3-R01

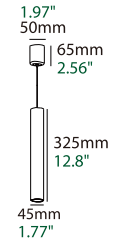

Basic Information

Model	GND3-R01
Mounting	Surface mounted
Finishing Color	White/Black
Reflector Color	White/Black/Golden
Material	Cold Forged Pure Alu. (Heat Sink)/Die-casting Alu.
IP Rating	IP20
Power	Max. 8W
Input Voltage	DC36V
Input Current	Max. 200mA

Optical Parameters

Light Source	LED COB
Lumens	65lm/W
CRI	97Ra
CCT	3000K ● 3500K ● 4000K ○
CCT Changeable	2700K — 6000K 1800K — 3000K
LED Lifespan	50000hrs

Driver Voltage	AC100-120V AC220-240V
Driver Options	ON/OFF DIM TRIAC/ PHASE-CUT DIM 0/1-10V DIM DALI

MINI 0"



MINI 0"

LN75-R25Q



LN75-R25QS



LN75-R25QT



With Trim

Trimless

White



Black

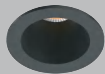

LN75-R25QS



20mm
0.78"
29mm
1.14"
∅ 25mm
0.98"

53mm
2.08"

LN75-R25QT

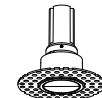

25mm
0.98"
60mm
2.36"
∅ 29mm
1.14"

58mm
2.28"

Basic Information

Model	LN75-R25QS/T
Embedded Parts	White
Mounting	Recessed
Trim Finishing Color	White
Reflector Color	White/Black
Material	Cold Forged Pure Alu. (Heat Sink)/Die-casting Alu.
Cutout Size	∅ 25mm / ∅ 29mm
IP Rating	IP20
Power	Max.6W
Input Voltage	DC36V
Input Current	Max. 120mA

Optical Parameters

Light Source	LED COB
Lumens	45lm/W
CRI	90Ra
CCT	3000K ● 3500K ● 4000K ○
Beam Angle	▲ 15° ▲ 25° ▲ 20° x 50°
UGR	< 10
LED Lifespan	50000hrs

Driver Voltage AC100-120V AC220-240V

Driver Options ON/OFF

LN75-R26Q



LN75-R26QS

LN75-R26QT



With Trim

Trimless

White



Black



Gold

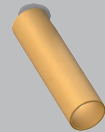
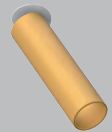

LN75-R26QS

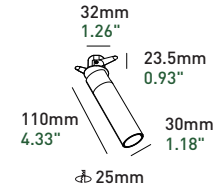

LN75-R26QT

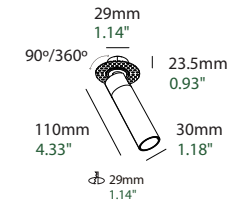

Basic Information

Model	LN75-R26QS/T
Embedded Parts	With Trim/Trimless
Mounting	Recessed
Trim Finishing Color	White
Reflector Color	White/Black/Gold
Material	Pure aluminum
Cutout Size	∅ 25mm / ∅ 29mm
Light Direction	↓ 90° ↻ 360°
IP Rating	IP20
Power	Max.8W
Input Voltage	DC36V
Input Current	Max. 200mA

Optical Parameters

Light Source	LED COB
Lumens	65lm/W 90lm/W
CRI	97Ra/90Ra
CCT	3000K ● 3500K ● 4000K ○
CCT Changeable	2700K — 6000K 1800K — 3000K
Beam Angle	▲ 15° ▲ 25° ▲ 35°
UGR	< 9
LED Lifespan	50000hrs

Driver Voltage	AC100-120V AC220-240V
Driver Options	ON/OFF DIM TRIAC/ PHASE-CUT DIM 0/1-10V DIM DALI



GAIA 75 Family

GAIA R75



GA75-R01QS

GA75-R01QT



With Trim

Trimless

White

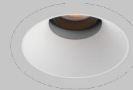
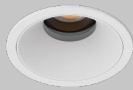

Black

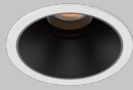

Golden

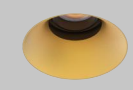
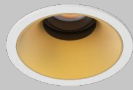

GA75-R01QS



GA75-R01QT

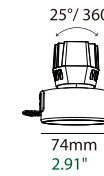

Basic Information

Model	GA75-R01QS/R01QT
Embedded Parts	With Trim/Trimless
Mounting	Recessed
Trim Finishing Color	White/Black
Reflector Color	White/Black/Golden
Material	Aluminum
Cutout Size	75mm
Light Direction	25° / 360°
IP Rating	IP20
Power	Max. 12W
Input Voltage	DC36V
Input Current	Max. 300mA

Optical Parameters

Light Source	LED COB
Lumens	65lm/W 90lm/W
CRI	97Ra / 90Ra
CCT	3000K ● 3500K ● 4000K ○
CCT Changeable	2700K — 6000K 1800K — 3000K
Beam Angle	15° 25° 35° 50°
Shielding Angle	46°
UGR	< 13
LED Lifespan	50000hrs

Driver Voltage	AC100-120V AC220-240V
Driver Options	ON/OFF DIM TRIAC/ PHASE-CUT DIM 0/1-10V DIM DALI

GAIA R75 Snout L



GA75-R03QS

GA75-R03QT

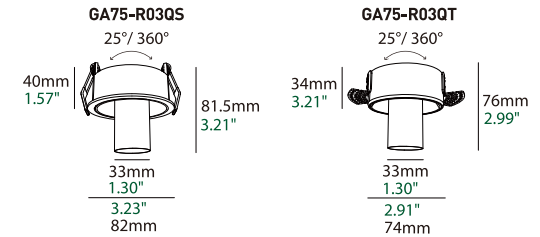
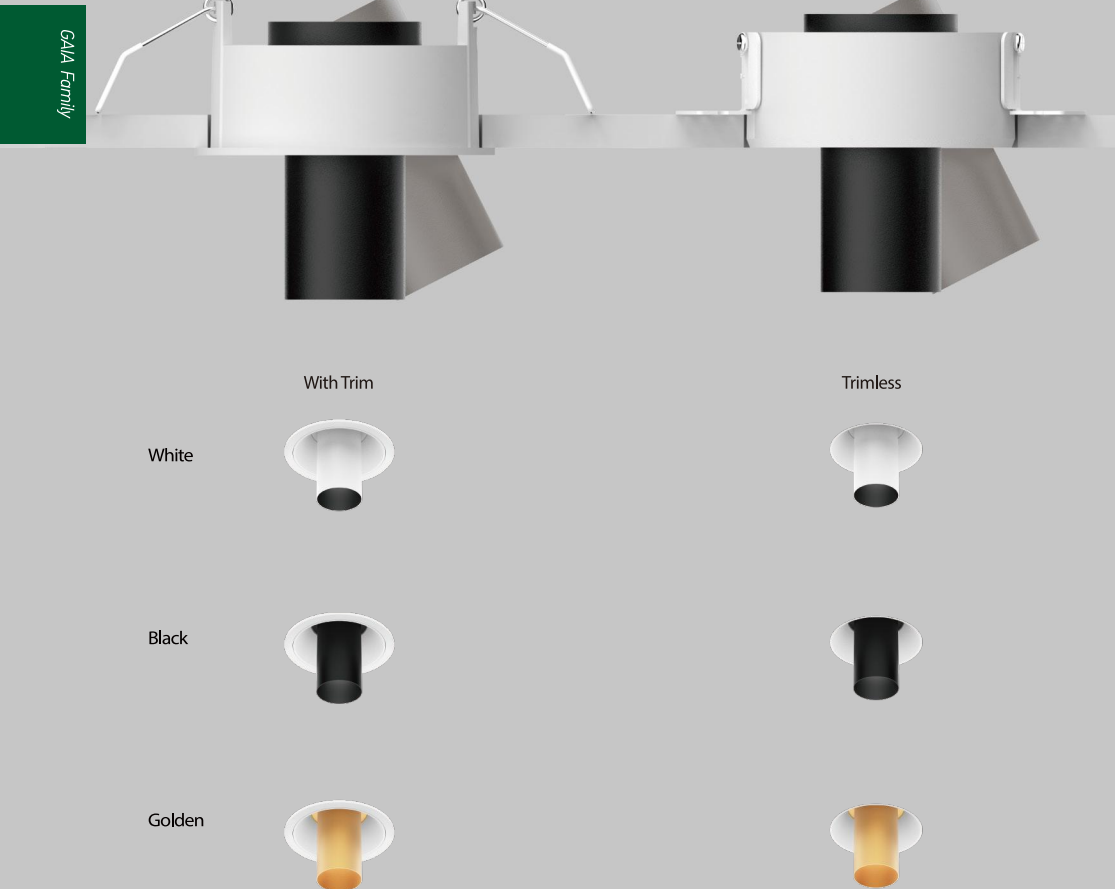

Basic Information

Model	GA75-R03QS/R03QT
Embedded Parts	With Trim/Trimless
Mounting	Recessed
Trim Finishing Color	White/Black
Reflector Color	White/Black/Golden
Material	Aluminum
Cutout Size	∅ 75mm
Light Direction	⬇ 25° ⬅ 360°
IP Rating	IP20
Power	Max. 8W
Input Voltage	DC36V
Input Current	Max. 200mA

Optical Parameters

Light Source	LED COB
Lumens	65lm/W 90lm/W
CRI	97Ra / 90Ra
CCT	3000K ● 3500K ● 4000K ○
CCT Changeable	2700K — 6000K 1800K — 3000K
Beam Angle	⌵ 15° ⌵ 25° ⌵ 35°
Shielding Angle	60°
UGR	< 9
LED Lifespan	50000hrs

Driver Voltage	AC100-120V AC220-240V
Driver Options	ON/OFF DIM TRIAC/ PHASE-CUT DIM 0/1-10V DIM DALI

GAIA R75 Snout



GA75-R05QS

GA75-R05QT



With Trim

Trimless

White

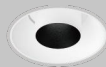
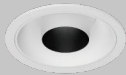

Black

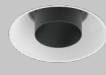
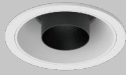

Golden

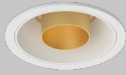

GA75-R05QS

25°/ 360°

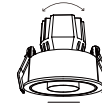

75mm
2.95"

33mm
1.30"

82mm
3.23"

GA75-R05QT

25°/ 360°

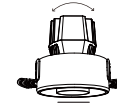

75mm
2.95"

33mm
1.30"

74mm
2.91"

Basic Information

Model	GA75-R05QS/R05QT
Embedded Parts	With Trim/Trimless
Mounting	Recessed
Trim Finishing Color	White/Black
Reflector Color	White/Black/Golden
Material	Aluminum
Cutout Size	75mm
Light Direction	25° 360°
IP Rating	IP20
Power	Max. 12W
Input Voltage	DC36V
Input Current	Max. 300mA

Optical Parameters

Light Source	LED COB
Lumens	65lm/W 90lm/W
CRI	97Ra / 90Ra
CCT	3000K 3500K 4000K
CCT Changeable	2700K 6000K 1800K 3000K
Beam Angle	15° 25° 35°
Shielding Angle	60°
UGR	<9
LED Lifespan	50000hrs

Driver Voltage	AC100-120V AC220-240V
Driver Options	ON/OFF DIM TRIAC/ PHASE-CUT DIM 0/1-10V DIM DALI

GA75-R06Q



GA75-R06QS



GA75-R06QT

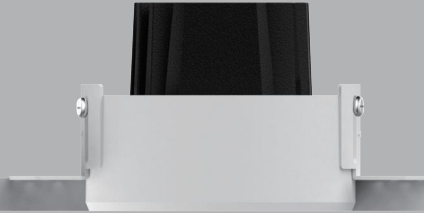

With Trim

Trimless

White

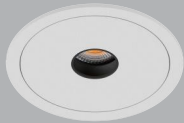

Black

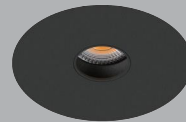
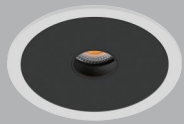

GA75-R06QS

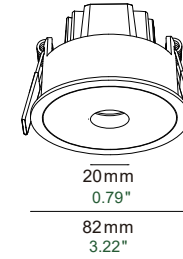

GA75-R06QT

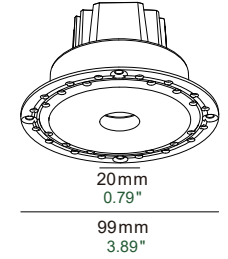

57mm
2.24"

57mm
2.24"

Basic Information

Model	GA75-R06Q
Embedded Parts	With Trim/Trimless
Mounting	Recessed
Trim Finishing Color	White/Black
Reflector Color	White/Black
Material	Aluminum
Cutout Size	75mm
IP Rating	IP20
Power	Max. 12W
Input Voltage	DC36V
Input Current	Max. 300mA

Optical Parameters

Light Source	LED COB
Lumens	50lm/W
CRI	97Ra
CCT	3000K ● 3500K ● 4000K ○
CCT Changeable	2700K 6000K 1800K 3000K
Beam Angle	25°
LED Lifespan	50000hrs
Driver Voltage	AC100-120V AC220-240V
Driver Options	ON/OFF DIM TRIAC/ PHASE-CUT DIM 0/1-10V DIM DALI

GA75-R08Q



GA75-R08QS

GA75-R08QT



With Trim

Trimless

White



Black



Gold

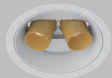

Multiple lighting methods

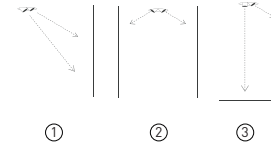

GA75-R08QS

2*25° / 360°

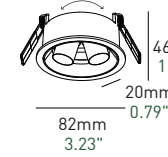

GA75-R08QT

2*25° / 360°

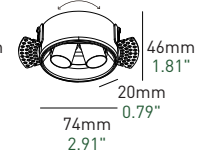

Basic Information

Model	GA75-R08Q
Embedded Parts	With Trim/Trimless
Mounting	Recessed
Trim Finishing Color	White
Reflector Color	White/Black/Gold
Material	Pure aluminum
Cutout Size	∅ 75mm
Light Direction	2*25° 360°
IP Rating	IP20
Power	Max.8W
Input Voltage	DC36V
Input Current	Max.180mA

Optical Parameters

Light Source	LED COB
Lumens	45lm/W
CRI	90Ra
CCT	3000K 3500K 4000K
Beam Angle	15° 25° 20° × 50°
UGR	< 10
LED Lifespan	50000hrs

Driver Voltage	AC100-120V AC220-240V
Driver Options	ON/OFF DIM TRIAC/ PHASE-CUT DIM 0/1-10V DIM DALI

GAIA Family

Technology

Brushed

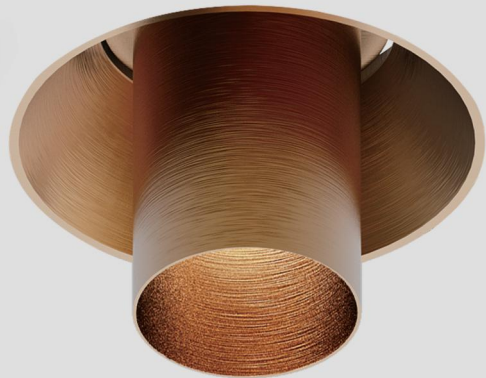

Material

Aluminum

GA75-R33Q



GA75-R33QS

GA75-R33QT

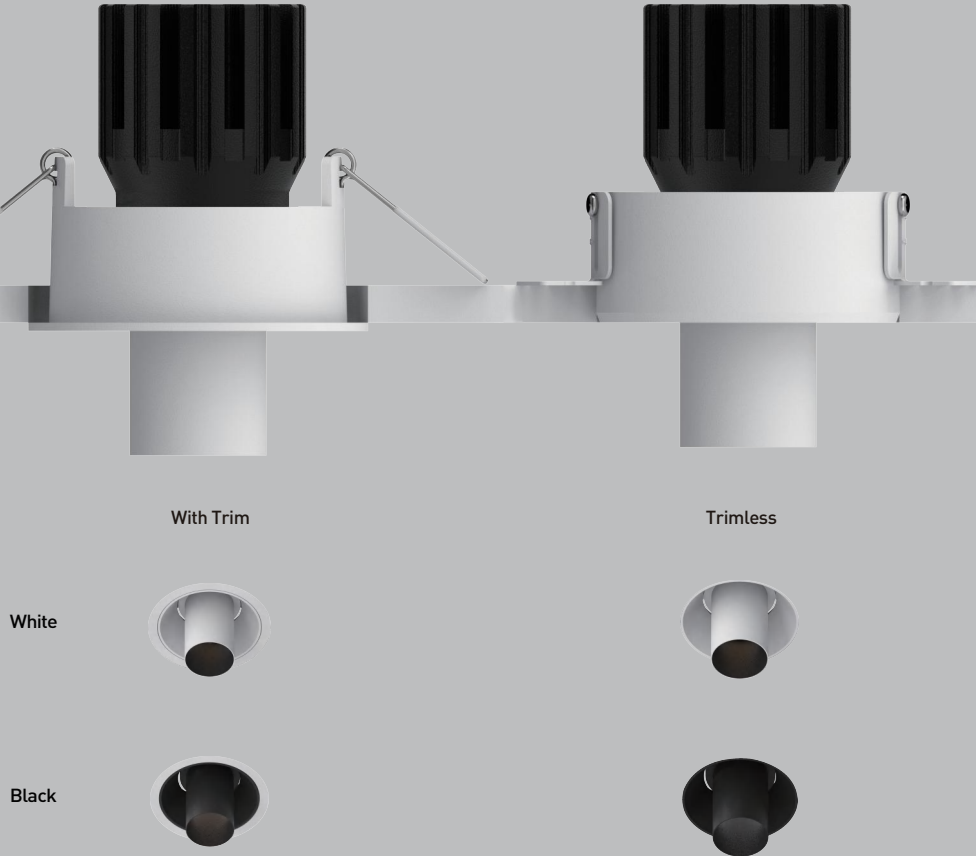

With Trim

Trimless

White

Black

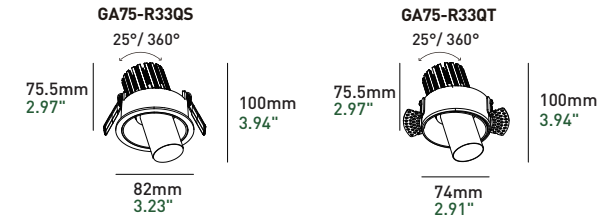

Basic Information

Model	GA75-R33Q
Embedded Parts	With Trim/Trimless
Mounting	Recessed
Trim Finishing Color	White
Reflector Color	White/Black
Material	Pure aluminum 6063
Cutout Size	75mm
Light Direction	25° 360°
IP Rating	IP20
Power	Max.15W
Input Voltage	DC36V
Input Current	Max. 350mA

Optical Parameters

Light Source	LED COB
Lumens	65lm/W 90lm/W
CRI	97Ra/90Ra
CCT	3000K 3500K 4000K
CCT Changeable	2700K 6000K 1800K 3000K
Beam Angle	25°
UGR	< 9
LED Lifespan	50000hrs

Accessories
(optional)



Driver Voltage	AC100-120V AC220-240V
Driver Options	ON/OFF DIM TRIAC/ PHASE-CUT DIM 0/1-10V DIM DALI



GA75-R09Q



GA75-R09QS



With Trim

GA75-R09QT



Trimless

W+W



B+W



B+B

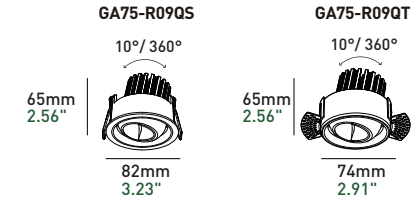

Basic Information

Model	GA75-R09Q
Embedded Parts	With Trim/Trimless
Mounting	Recessed
Trim Finishing Color	White
Reflector Color	White/Black
Material	Pure aluminum 6063
Cutout Size	75mm
Light Direction	10° 360°
IP Rating	IP20
Power	Max. 12W
Input Voltage	DC36V
Input Current	Max. 300mA

Optical Parameters

Light Source	LED COB
Lumens	65lm/W
CRI	97Ra
CCT	3000K ● 3500K ● 4000K ○
CCT Changeable	2700K 6000K
LED Lifespan	50000hrs

Accessories (optional)

Driver Voltage	AC100-120V AC220-240V
Driver Options	ON/OFF DIM TRIAC/ PHASE-CUT DIM 0/1-10V DIM DALI

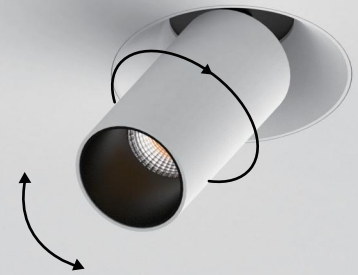

65°/360°

GA75-R43Q



GA75-R43QS

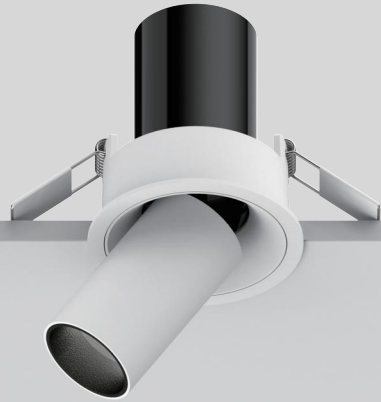

With Trim

GA75-R43QT

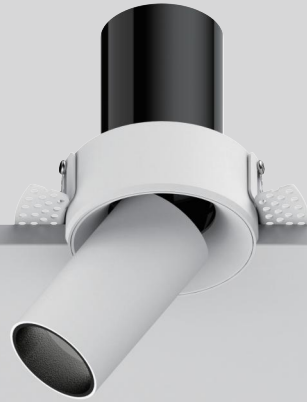

Trimless

W+W

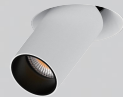

B+W

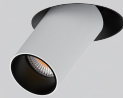

B+B

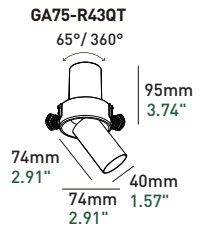
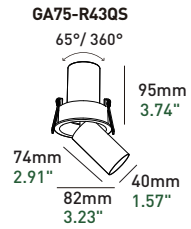
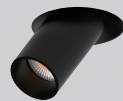

GAIA Family

Basic Information

Model	GA75-R43Q
Embedded Parts	With Trim/Trimless
Mounting	Recessed
Trim Finishing Color	White
Reflector Color	White/Black
Material	Pure aluminum 6063
Cutout Size	75mm
Light Direction	65° 360°
IP Rating	IP20
Power	Max.10W
Input Voltage	DC36V
Input Current	Max.250mA

Optical Parameters

Light Source	LED COB
Lumens	65lm/W
CRI	97Ra
CCT	3000K 3500K 4000K
CCT Changeable	2700K 6000K 1800K 3000K
Beam Angle	15° 25° 35°
UGR	< 9
LED Lifespan	50000hrs

Accessories (optional)



Driver Voltage	AC100-120V AC220-240V
Driver Options	ON/OFF DIM TRIAC/ PHASE-CUT DIM 0/1-10V DIM DALI

GA75-R35Q

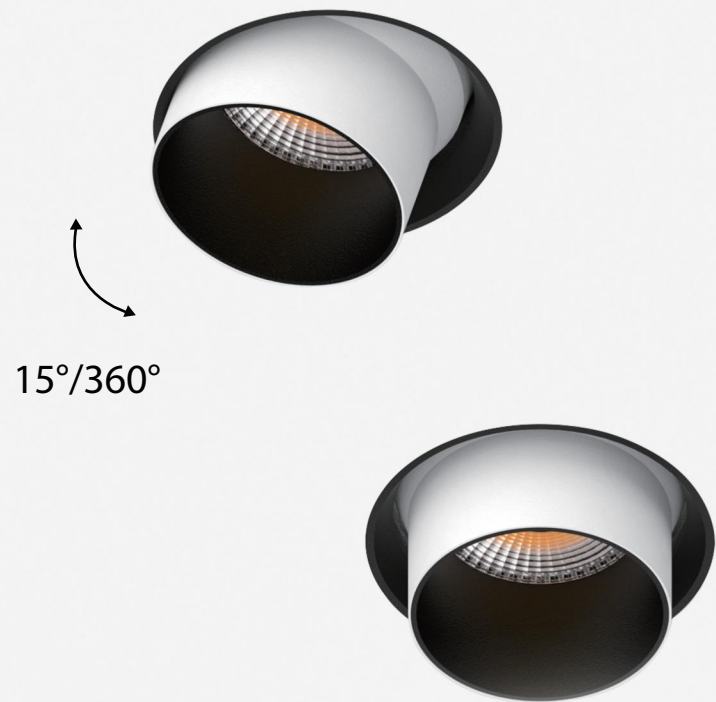

GA75-R35Q



GA75-R35QS

GA75-R35QT



With Trim

Trimless

W+W

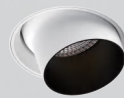

B+W

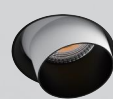

B+B

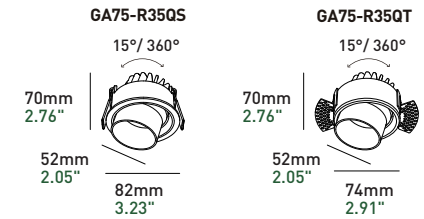
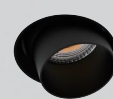

Basic Information

Model	GA75-R35Q
Embedded Parts	With Trim/Trimless
Mounting	Recessed
Trim Finishing Color	White
Reflector Color	White/Black
Material	Pure aluminum 6063
Cutout Size	75mm
Light Direction	15° 360°
IP Rating	IP20
Power	Max. 15W
Input Voltage	DC36V
Input Current	Max. 350mA

Optical Parameters

Light Source	LED COB
Lumens	65lm/W
CRI	97Ra
CCT	3000K 3500K 4000K
CCT Changeable	2700K 6000K 1800K 3000K
Beam Angle	15° 25° 35° 60°
UGR	< 13
LED Lifespan	50000hrs

Accessories
(optional)



GA75-R45Q



GAIA Family

GA75-R45QS

GA75-R45QT



With Trim

Trimless

White



Black

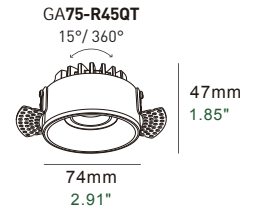
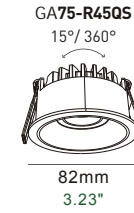

Basic Information

Model	GA75-R45Q
Embedded Parts	With TriGTrimless
Mounting	Recessed
Trim Finishing Color	White/Black
Reflector Color	White/Black
Material	Pure aluminum
Cutout Size	∅ 75mm
Light Direction	15° 360°
IP Rating	IP20
Power	Max.8W
Input Voltage	DC36V
Input Current	Max. 200mA

Optical Parameters

Light Source	LED COB
Lumens	65lm/W 90lm/W
CRI	97Ra/90Ra
CCT	3000K 3500K 4000K
CCT Changeable	2700K 6000K 1800K 3000K
Beam Angle	15° 25° 35° 50°
UGR	< 16
LED Lifespan	50000hrs

Driver Voltage	AC100-120V AC220-240V
Driver Options	ON/OFF DIM TRIAC/ PHASE-CUT DIM 0/1-10V DIM DALI

GA75-R65QS



GA75-R65QS



With Trim

White



Black

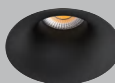

GA75-R65QS

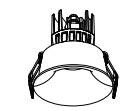

79mm
3.11"

82mm
3.23"

GAIA Family

Basic Information

Model	GA75-R65QS
Embedded Parts	With Trim
Mounting	Recessed
Trim Finishing Color	White/Black
Reflector Color	White/Black
Material	Aluminum
Cutout Size	75mm
IP Rating	IP65
Power	Max. 12W
Input Voltage	DC36V
Input Current	Max. 300mA

Optical Parameters

Light Source	LED COB
Lumens	65lm/W 90lm/W
CRI	97Ra / 90Ra
CCT	3000K ● 3500K ● 4000K ○
CCT Changeable	2700K — 6000K 1800K — 3000K
Beam Angle	15° 25° 35° 50°
UGR	< 13
LED Lifespan	50000hrs

Driver Voltage	AC100-120V AC220-240V
Driver Options	ON/OFF DIM TRIAC/ PHASE-CUT DIM 0/1-10V DIM DALI

GAIA R75-S



GA75-R01QS (with plate M-GA01-K01)

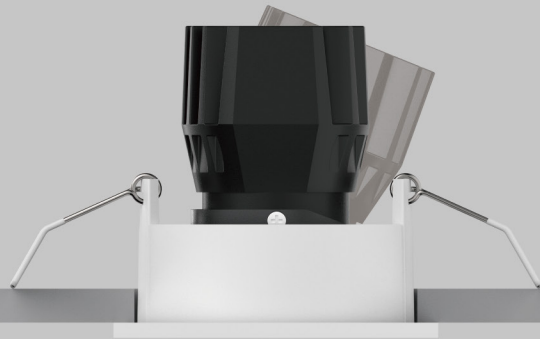

White

Black

White



Black



GA75-R01QS (with plate M-GA01-K01)

M-GA01-K01



GA75-R01QS



25° / 360°



83mm
3.27"

82mm
3.23"
86mm
3.39"

Basic Information

Model	GA75-R01QS (with plate M-GA01-K01)
Embedded Parts	With Trim
Mounting	Recessed
Trim Finishing Color	White/Black
Reflector Color	White/Black
Material	Aluminum
Cutout Size	∅ 75mm
Light Direction	25° 360°
IP Rating	IP20
Power	Max.12W
Input Voltage	DC36V
Input Current	Max. 300mA

Optical Parameters

Light Source	LED COB
Lumens	65lm/W 90lm/W
CRI	97Ra / 90Ra
CCT	3000K ● 3500K ● 4000K ○
CCT Changeable	2700K — 6000K 1800K — 3000K
Beam Angle	15° 25° 35° 50°
Shielding Angle	46°
UGR	< 13
LED Lifespan	50000hrs

Driver Voltage AC100-120V AC220-240V

Driver Options ON/OFF DIM TRIAC/ PHASE-CUT DIM 0/1-10V DIM DALI

GAIA R75-2S



Double GA75-R01QS (with plate M-GA01-K02)

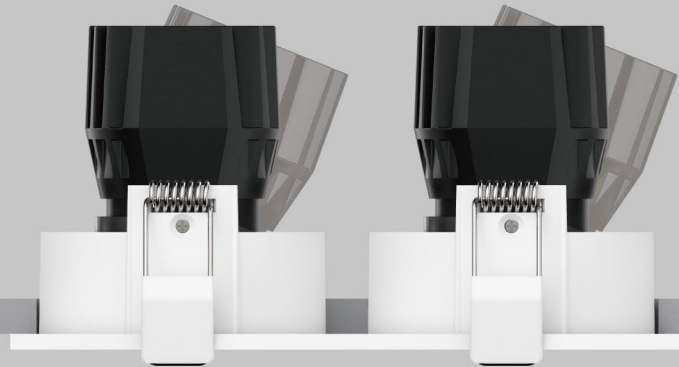

White

Black

White



Black



Double GA75-R01QS (with plate M-GA01-K02)

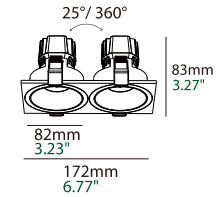
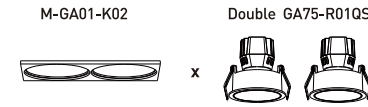

Basic Information

Model	Double GA75-R01QS (with plate M-GA01-K02)
Embedded Parts	With Trim
Mounting	Recessed
Trim Finishing Color	White/Black
Reflector Color	White/Black
Material	Aluminum
Cutout Size	160*75mm
Light Direction	25° 360°
IP Rating	IP20
Power	Max. 2*12W
Input Voltage	DC36V
Input Current	Max. 2*300mA

Optical Parameters

Light Source	LED COB
Lumens	65lm/W 90lm/W
CRI	97Ra / 90Ra
CCT	3000K 3500K 4000K
CCT Changeable	2700K 6000K 1800K 3000K
Beam Angle	15° 25° 35° 50°
Shielding Angle	46°
UGR	< 13
LED Lifespan	50000hrs

Driver Voltage	AC100-120V AC220-240V
Driver Options	ON/OFF DIM TRIAC/ PHASE-CUT DIM 0/1-10V DIM DALI

GAIA S75 Single



GAIA Family

GA75-S01QS

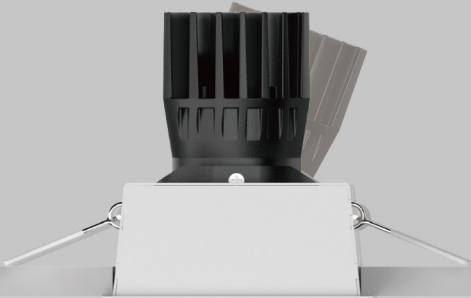

GA75-S01QT

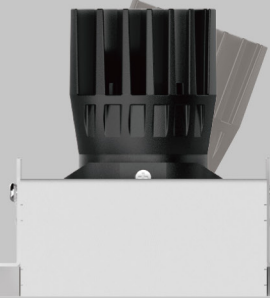

With Trim

Trimless

White



Black



Golden

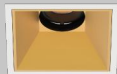

GA75-S01QS

25°/360°



82mm
3.23"

87mm
3.43"

GA75-S01QT

25°/360°

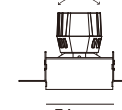

74mm
2.91"

87mm
3.43"

Basic Information

Model	GA75-S01QS/S01QT
Embedded Parts	With Trim/Trimless
Mounting	Recessed
Trim Finishing Color	White/Black
Reflector Color	White/Black/Golden
Material	Aluminum
Cutout Size	75*75mm
Light Direction	25° 360°
IP Rating	IP20
Power	Max. 12W
Input Voltage	DC36V
Input Current	Max. 300mA

Optical Parameters

Light Source	LED COB
Lumens	65lm/W 90lm/W
CRI	97Ra / 90Ra
CCT	3000K 3500K 4000K
CCT Changeable	2700K 6000K 1800K 3000K
Beam Angle	15° 25° 35° 50°
Shielding Angle	46°
UGR	< 13
LED Lifespan	50000hrs

Driver Voltage	AC100-120V AC220-240V
Driver Options	ON/OFF DIM TRIAC/ PHASE-CUT DIM 0/1-10V DIM DALI

GAIA S75 Double



GA75-S01QS2

GA75-S01QT2

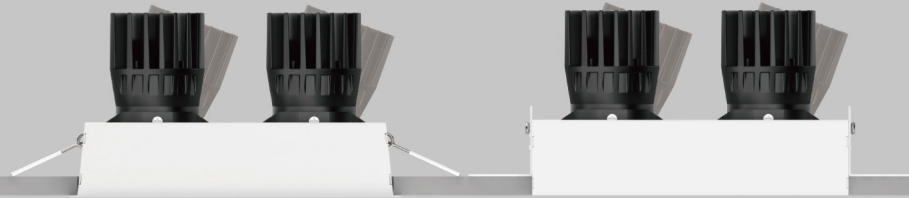

With Trim

Trimless

White



Black



Golden

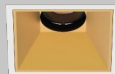

GA75-S01QS2

25°/360°

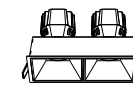

156*82mm
6.14*3.23"

87mm
3.43"

GA75-S01QT2

25°/360°

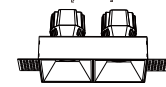

148*74mm
5.83*2.91"

87mm
3.43"

Basic Information

Model	GA75-S01QS2/S01QT2
Embedded Parts	With Trim/Trimless
Mounting	Recessed
Trim Finishing Color	White/Black
Reflector Color	White/Black/Golden
Material	Aluminum
Cutout Size	150*75mm
Light Direction	25° 360°
IP Rating	IP20
Power	Max. 2*12W
Input Voltage	DC36V
Input Current	Max. 2*300mA

Optical Parameters

Light Source	LED COB
Lumens	65lm/W 90lm/W
CRI	97Ra / 90Ra
CCT	3000K 3500K 4000K
CCT Changeable	2700K 6000K 1800K 3000K
Beam Angle	15° 25° 35° 50°
Shielding Angle	46°
UGR	< 13
LED Lifespan	50000hrs

Driver Voltage	AC100-120V AC220-240V
Driver Options	ON/OFF DIM TRIAC/ PHASE-CUT DIM 0/1-10V DIM DALI

GAIA 55 Family

GAIA Family



GA55-R01Q



GA55-R01QS

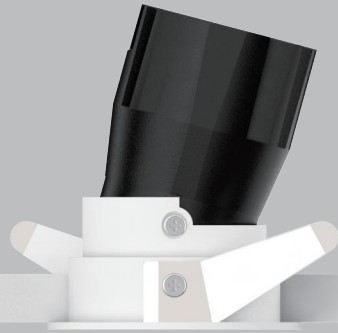

GA55-R01QT



With Trim

Trimless

White



Black



GA55-R01QS

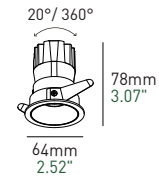

GA55-R01QT

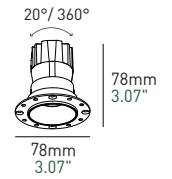

GAIA Family

Basic Information

Model	GA55-R01QS/T
Embedded Parts	With Trim/Trimless
Mounting	Recessed
Trim Finishing Color	White/Black
Reflector Color	White/Black
Material	Aluminum
Cutout Size	55mm
Light Direction	20° 360°
IP Rating	IP20
Power	Max.10W
Input Voltage	DC36V
Input Current	Max. 250mA

Optical Parameters

Light Source	LED COB
Lumens	65lm/W 90lm/W
CRI	97Ra/ 90Ra
CCT	3000K 3500K 4000K
CCT Changeable	2700K 6000K 1800K 3000K
Beam Angle	35°
Shielding Angle	48°
UGR	<8
LED Lifespan	50000hrs
Driver Voltage	AC100-120V AC220-240V
Driver Options	ON/OFF DIM TRIAC/ PHASE-CUT DIM 0/1-10V DIM DALI



GA55-R03Q



GA55-R03QS

GA55-R03QT



With Trim

Trimless

White



Black



Gold

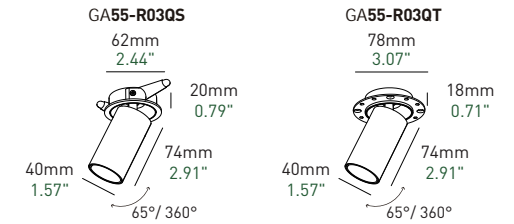

Basic Information

Model	GA55-R03Q
Embedded Parts	With Trim/Trimless
Mounting	Recessed
Trim Finishing Color	White
Reflector Color	White/Black/Gold
Material	Pure aluminum
Cutout Size	∅ 55mm
Light Direction	65° 360°
IP Rating	IP20
Power	Max.10W
Input Voltage	DC36V
Input Current	Max. 250mA

Optical Parameters

Light Source	LED COB
Lumens	65lm/W 90lm/W
CRI	97Ra/90Ra
CCT	3000K 3500K 4000K
CCT Changeable	2700K 6000K 1800K 3000K
Beam Angle	15° 25° 35°
UGR	< 9
LED Lifespan	50000hrs

Driver Voltage	AC100-120V AC220-240V
Driver Options	ON/OFF DIM TRIAC/ PHASE-CUT DIM 0/1-10V DIM DALI

GAIA Family

GA55-R44Q



GA55-R44QS



GA55-R44QT



With Trim

White

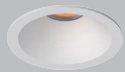

Trimless

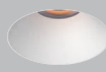

Black

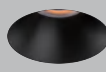
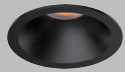

GA55-R44QS

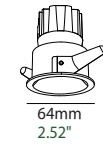

GA55-R44QT

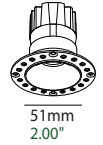

GAIA Family

Basic Information

Model	GA55-R44QS/T
Embedded Parts	With Trim/Trimless
Mounting	Recessed
Trim Finishing Color	White/Black
Reflector Color	White/Black
Material	Aluminum
Cutout Size	55mm
Light Direction	Fixed
IP Rating	IP44
Power	Max. 10W
Input Voltage	DC36V
Input Current	Max. 250mA

Optical Parameters

Light Source	LED COB
Lumens	65lm/W 90lm/W
CRI	97Ra / 90Ra
CCT	3000K ● 3500K ● 4000K ○
CCT Changeable	2700K — 6000K 1800K — 3000K
Beam Angle	15° 25° 35° 50°
Shielding Angle	38°
UGR	< 16
LED Lifespan	50000hrs

Driver Voltage	AC100-120V AC220-240V
Driver Options	ON/OFF DIM TRIAC/ PHASE-CUT DIM 0/1-10V DIM DALI

GA55-R65Q



GA55-R65QS

GA55-R65QT

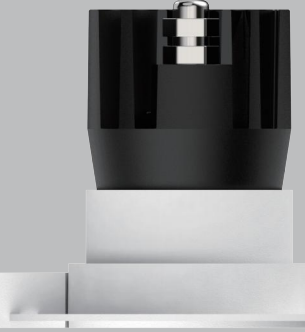
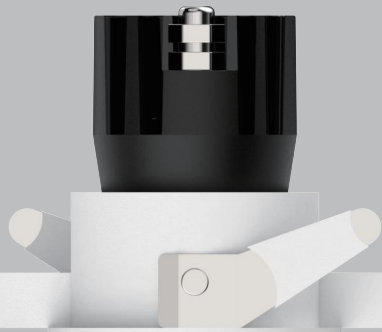

With Trim

Trimless

White



Black

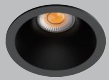

GA55-R65QS

GA55-R65QT



72mm
2.83"

64mm
2.52"



72mm
2.83"

78mm
3.07"

GAIA Family

Basic Information

Model	GA55-R65QS/R65QT
Embedded Parts	With Trim/Trimless
Mounting	Recessed
Trim Finishing Color	White/Black
Reflector Color	White/Black
Material	Aluminum
Cutout Size	∅ 55mm
Light Direction	Fixed
IP Rating	IP65
Power	Max. 10W
Input Voltage	DC36V
Input Current	Max. 250mA

Optical Parameters

Light Source	LED COB
Lumens	65lm/W 90lm/W
CRI	97Ra / 90Ra
CCT	3000K ● 3500K ● 4000K ○
CCT Changeable	2700K — 6000K 1800K — 3000K
Beam Angle	▮ 15° ▮ 25° ▮ 35° ▮ 50°
Shielding Angle	38°
UGR	< 16
LED Lifespan	50000hrs

Driver Voltage	AC100-120V AC220-240V
Driver Options	ON/OFF DIM TRIAC/ PHASE-CUT DIM 0/1-10V DIM DALI

GAIA R55 Semi-recessed



GA55-R11QS

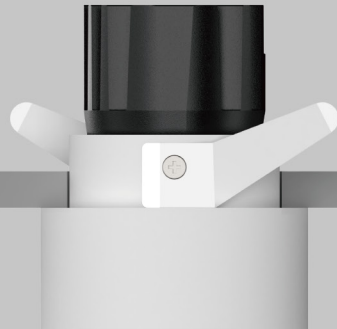

White



Black



Golden

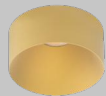

GAIA Family



GA55-R11QS

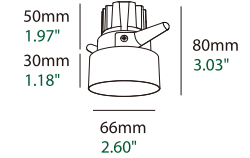

Basic Information

Model	GA55-R11QS
Mounting	Semi-recessed
Trim Finishing Color	White/Black
Reflector Color	White/Black/Golden
Material	Aluminum
Cutout Size	∅ 55mm
IP Rating	IP20
Power	Max. 10W
Input Voltage	DC36V
Input Current	Max. 250mA

Optical Parameters

Light Source	LED COB
Lumens	65lm/W 90lm/W
CRI	97Ra / 90Ra
CCT	3000K ● 3500K ● 4000K ○
CCT Changeable	2700K — 6000K 1800K — 3000K
Beam Angle	▲ 15° ▲ 25° ▲ 35° ▲ 50°
Shielding Angle	42°
UGR	< 13
LED Lifespan	50000hrs

Driver Voltage AC100-120V AC220-240V

Driver Options ON/OFF DIM TRIAC/ PHASE-CUT DIM 0/1-10V DIM DALI

GAIA R55 Trumpet



GA55-R21QS

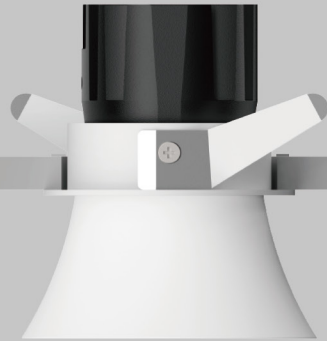

White



Black



Golden



GA55-R21QS

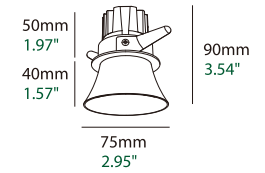

Basic Information

Model	GA55-R21QS
Mounting	Semi-recessed
Trim Finishing Color	White/Black
Reflector Color	White/Black/Golden
Material	Aluminum
Cutout Size	∅ 55mm
IP Rating	IP20
Power	Max. 10W
Input Voltage	DC36V
Input Current	Max. 250mA

Optical Parameters

Light Source	LED COB
Lumens	65lm/W 90lm/W
CRI	97Ra / 90Ra
CCT	3000K ● 3500K ● 4000K ○
CCT Changeable	2700K — 6000K 1800K — 3000K
Beam Angle	15° 25° 35° 50°
Shielding Angle	55°
UGR	<9
LED Lifespan	50000hrs

Driver Voltage	AC100-120V AC220-240V
Driver Options	ON/OFF DIM TRIAC/ PHASE-CUT DIM 0/1-10V DIM DALI

GA55-R05Q



GA55-R05QS

GA55-R05QT

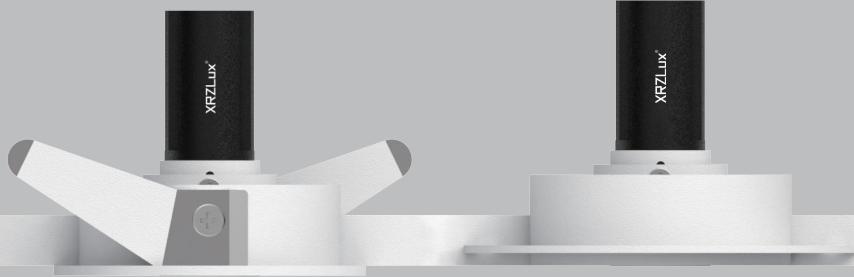

With Trim

Trimless

White



Black



Gold

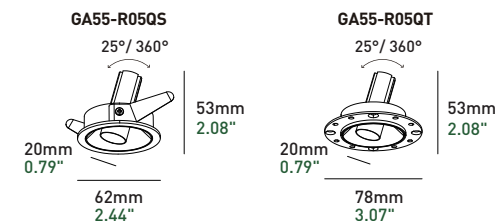
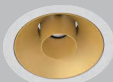

Basic Information

Model	GA55-R05Q
Embedded Parts	With Trim/Trimless
Mounting	Recessed
Trim Finishing Color	White
Reflector Color	White/Black/Gold
Material	Pure aluminum 6063
Cutout Size	55mm
Light Direction	25° 360°
IP Rating	IP20
Power	Max.6W
Input Voltage	DC36V
Input Current	Max. 120mA

Optical Parameters

Light Source	LED COB
Lumens	45lm/W
CRI	90Ra
CCT	3000K 3500K 4000K
Beam Angle	15° 25°
UGR	< 10
LED Lifespan	50000hrs

Driver Voltage	AC100-120V AC220-240V
----------------	-----------------------

GA55 Family

GA55-R48Q



GA55-R48QS

GA55-R48QT



With Trim

Trimless

White



Black



GA55-R48QS

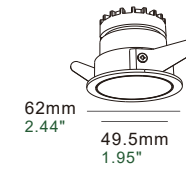

48mm
1.89"

GA55-R48QT

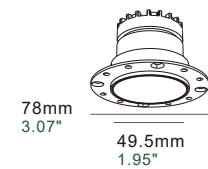

48mm
1.89"

Basic Information

Model	GA55-R48Q
Embedded Parts	With Trim/Trimless
Mounting	Recessed
Trim Finishing Color	White
Reflector Color	White/Black
Material	Pure aluminum 6063
Cutout Size	∅ 55mm
Light Direction	↔ 360°
IP Rating	IP20
Power	Max.8W
Input Voltage	DC36V
Input Current	Max. 200mA

Optical Parameters

Light Source	LED COB
Lumens	65lm/W 90lm/W
CRI	97Ra/90Ra
CCT	3000K ● 3500K ● 4000K ○
CCT Changeable	2700K — 6000K 1800K — 3000K
Beam Angle	▮ 15° ▮ 25° ▮ 35° ▮ 50°
UGR	< 16
LED Lifespan	50000hrs

Driver Voltage	AC100-120V AC220-240V
Driver Options	ON/OFF DIM TRIAC/ PHASE-CUT DIM 0/1-10V DIM DALI

GA55-R09QS



GA55-R09QS

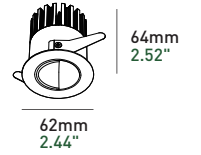

GA55 Family

Basic Information

Model	GA55-R09QS
Embedded Parts	With Trim
Mounting	Recessed
Trim Finishing Color	White
Reflector Color	White/Black
Material	Pure aluminum 6063
Cutout Size	55mm
IP Rating	IP20
Power	Max.12W
Input Voltage	DC36V
Input Current	Max. 300mA

Optical Parameters

Light Source	LED COB
Lumens	65lm/W
CRI	97Ra
CCT	3000K ● 3500K ● 4000K ○
CCT Changeable	2700K — 6000K 1800K — 3000K
LED Lifespan	50000hrs

Driver Voltage	AC100-120V AC220-240V
Driver Options	ON/OFF DIM TRIAC/ PHASE-CUT DIM 0/1-10V DIM DALI

GA55-R06Q

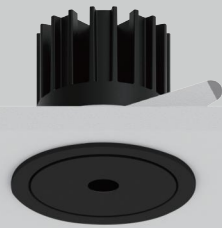

Black
GA55-R06QS



White
GA55-R06QT



GA55-R06QS

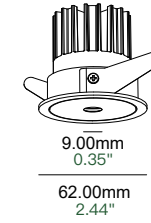

GA55-R06QT

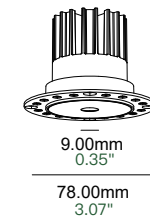

56.00mm
2.20"

56.00mm
2.20"

Basic Information

Model	GA55-R06Q
Embedded Parts	With Trim/Trimless
Mounting	Recessed
Trim Finishing Color	White/Black
Reflector Color	White/Black
Material	Pure aluminum 6063
Cutout Size	55mm
Light Direction	/
IP Rating	IP20
Power	Max. 10W
Input Voltage	DC36V
Input Current	Max. 250mA

Optical Parameters

Light Source	LED COB
Lumens	50lm/W
CRI	97Ra
CCT	2700K ● 3000K ● 3500K ● 4000K ○
Beam Angle	45°
UGR	< 6
LED Lifespan	50000hrs

Driver Voltage	AC100-120V AC220-240V
Driver Options	ON/OFF DIM TRIAC/ PHASE-CUT DIM 0/1-10V DIM DALI

Gypsum-like Curve Light →

75mm



- The light is diffused from the light source through the curved-surface, with a natural transition, soft light and even distribution.
- The extremely narrow 0.8mm edge fits seamlessly with the ceiling, making the fixture invisible, with lighting only.



0.8mm



1.9mm

· Stretchable Design

↻ 65° ↻ 360°

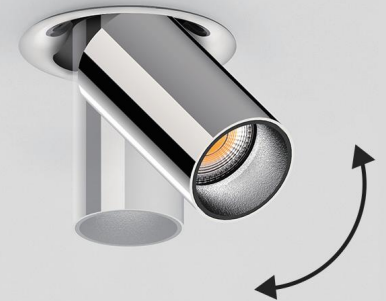

GA75-R63Q



White

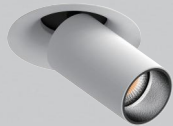

Black+White

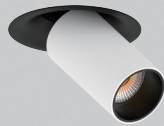

Silver

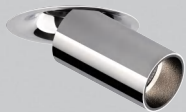

Black

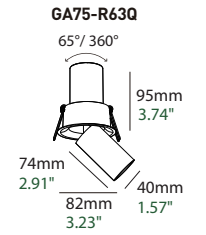
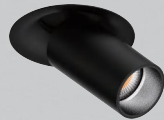

GA75 Family

Basic Information

Model	GA75-R63Q
Embedded Parts	With Trim
Mounting	Recessed
Trim Finishing Color	White/Black/Silver
Reflector Color	White/Black/Silver
Material	Pure aluminum 6063
Cutout Size	∅ 75mm
Light Direction	↓ 65° ↻ 360°
IP Rating	IP20
Power	Max.10W
Input Voltage	DC36V
Input Current	Max. 250mA

Optical Parameters

Light Source	LED COB
Lumens	65lm/W 90lm/W
CRI	97Ra / 90Ra
CCT	3000K ● 3500K ● 4000K ○
CCT Changeable	2700K — 6000K 1800K — 3000K
Beam Angle	⌵ 15° ⌵ 25° ⌵ 35°
UGR	< 9
LED Lifespan	50000hrs

Driver Voltage	AC100-120V AC220-240V
Driver Options	ON/OFF DIM TRIAC/ PHASE-CUT DIM 0/1-10V DIM DALI

GA75-R68QS



White



Black

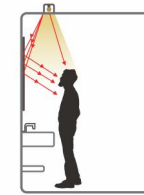

GA75-R68QS

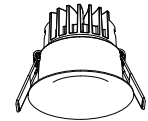

67.00mm
2.63"

82.00mm
3.23"

Basic Information

Model	GA75-R68QS
Mounting	Recessed
Trim Finishing Color	White/Black
Reflector Color	White/Black
Material	Pure aluminum 6063
Cutout Size	75mm
IP Rating	IP20
Power	Max.12W
Input Voltage	DC36V
Input Current	Max. 300mA

Optical Parameters

Light Source	LED COB
CRI	97Ra
CCT	2700K ● 3000K ● 3500K ● 4000K ○
CCT Changeable	2700K — 6000K 1800K — 3000K
LED Lifespan	50000hrs

Driver Voltage	AC100-120V AC220-240V
Driver Options	ON/OFF DIM TRIAC/ PHASE-CUT DIM 0/1-10V DIM DALI

GA75-R69QS



GA75-R69QS

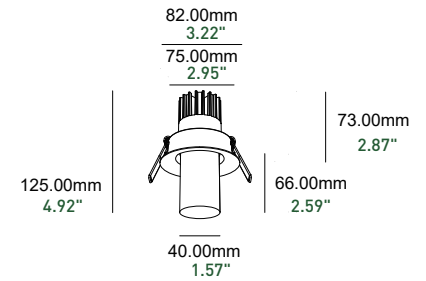

Basic Information

Model	GA75-R69QS
Mounting	Recessed
Trim Finishing Color	Silver
Reflector Color	Silver
Material	Pure aluminum 6063
Cutout Size	75mm
IP Rating	IP20
Power	Max.12W
Input Voltage	DC36V
Input Current	Max. 300mA

Optical Parameters

Light Source	LED COB
CRI	97Ra
CCT	2700K ● 3000K ● 3500K ● 4000K ●
CCT Changeable	2700K — 6000K 1800K — 3000K
LED Lifespan	50000hrs

Driver Voltage	AC100-120V AC220-240V
Driver Options	ON/OFF DIM TRIAC/ PHASE-CUT DIM 0/1-10V DIM DALI

GA55-R61QS



White

Black

Brushed Aluminum

Silver

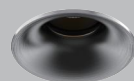
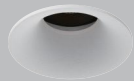

GA55-R61QS

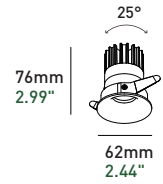

Gypsum-like Curve Light

Basic Information

Model	GA55-R61QS
Embedded Parts	With Trim/Trimless
Mounting	Recessed
Trim Finishing Color	White/Black/Brushed Aluminum/Silver
Reflector Color	White/Black/Brushed Aluminum/Silver
Material	Pure aluminum 6063
Cutout Size	55mm
Light Direction	25°
IP Rating	IP20
Power	Max.12W
Input Voltage	DC36V
Input Current	Max. 300mA

Optical Parameters

Light Source	LED COB
Lumens	65lm/W
CRI	97Ra
CCT	3000K ● 3500K ● 4000K ●
CCT Changeable	2700K — 6000K 1800K — 3000K
Beam Angle	▲ 15° ▲ 25° ▲ 35° ▲ 50°
UGR	< 9
LED Lifespan	50000hrs

Driver Voltage	AC100-120V AC220-240V
Driver Options	ON/OFF DIM TRIAC/ PHASE-CUT DIM 0/1-10V DIM DALI

GA55-R63QS



White



Black



Silver



GA55-R63QS

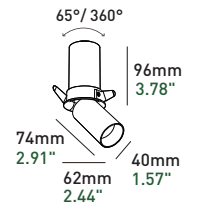

Basic Information

Model	GA55-R63QS
Embedded Parts	With Trim
Mounting	Recessed
Trim Finishing Color	White/Black/Silver
Reflector Color	White/Black/Silver
Material	Pure aluminum 6063
Cutout Size	55mm
Light Direction	65° 360°
IP Rating	IP20
Power	Max.10W
Input Voltage	DC36V
Input Current	Max. 250mA

Optical Parameters

Light Source	LED COB
Lumens	65lm/W
CRI	97Ra
CCT	3000K 3500K 4000K
CCT Changeable	2700K 6000K 1800K 3000K
Beam Angle	15° 25° 35°
UGR	< 9
LED Lifespan	50000hrs

Driver Voltage	AC100-120V AC220-240V
Driver Options	ON/OFF DIM TRIAC/ PHASE-CUT DIM 0/1-10V DIM DALI

LN75-R77Q



LN75-R77QS



LN75-R77QT



LN75-R77QS

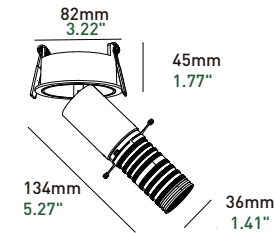

LN75-R77QT

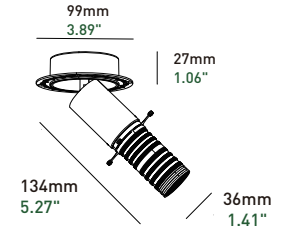

Basic Information

Model	LN75-R77QS/T
Embedded Parts	With Trim/Trimless
Mounting	Recessed
Trim Finishing Color	White
Reflector Color	Black
Material	Pure aluminum 6063
Cutout Size	75mm
Light Direction	90° 360°
IP Rating	IP20
Power	Max.8W
Input Voltage	DC36V
Input Current	Max. 200mA

Optical Parameters

Light Source	LED COB
CRI	97Ra
CCT	2700K ● 3000K ● 3500K ● 4000K ○
LED Lifespan	50000hrs

Driver Voltage	AC100-120V AC220-240V
Driver Options	ON/OFF DIM TRIAC/ PHASE-CUT DIM 0/1-10V DIM DALI

Accessories
(optional)



LN75-R75Q



LN75-R75QS



LN75-R75QT



LN75-R75QT

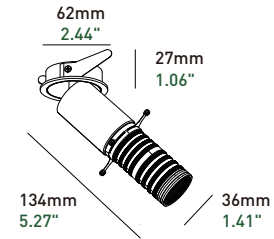

LN75-R75QT

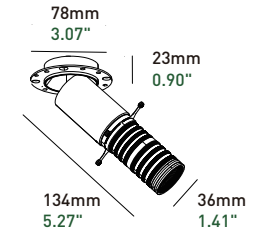

Basic Information

Model	LN75-R75QS/T
Embedded Parts	With Trim/Trimless
Mounting	Recessed
Trim Finishing Color	White
Reflector Color	Black
Material	Pure aluminum 6063
Cutout Size	55mm
Light Direction	90° 360°
IP Rating	IP20
Power	Max.8W
Input Voltage	DC36V
Input Current	Max.200mA

Optical Parameters

Light Source	LED COB
CRI	97Ra
CCT	2700K ● 3000K ● 3500K ● 4000K ○
LED Lifespan	50000hrs

Driver Voltage	AC100-120V AC220-240V
Driver Options	ON/OFF DIM TRIAC/ PHASE-CUT DIM 0/1-10V DIM DALI

LN75-R74Q

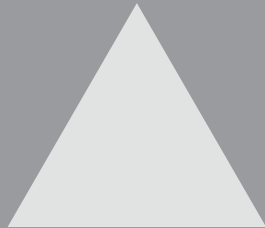

LN75-R74QS

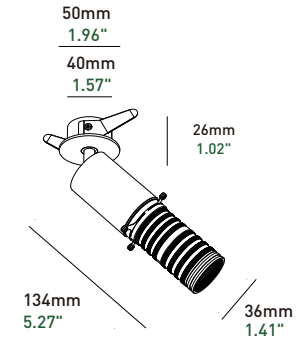

Basic Information

Model	LN75-R74QS
Mounting	Recessed
Trim Finishing Color	Black
Reflector Color	Black
Material	Pure aluminum 6063
Cutout Size	40mm
Light Direction	90° 360°
IP Rating	IP20
Power	Max.8W
Input Voltage	DC36V
Input Current	Max. 200mA

Optical Parameters

Light Source	LED COB
CRI	97Ra
CCT	2700K ● 3000K ● 3500K ● 4000K ○
LED Lifespan	50000hrs

Driver Voltage	AC100-120V AC220-240V
Driver Options	ON/OFF DIM TRIAC/ PHASE-CUT DIM 0/1-10V DIM DALI



HIGH Grille Series

HIGH Grille Series



HG-S05QS

HG-S05QT

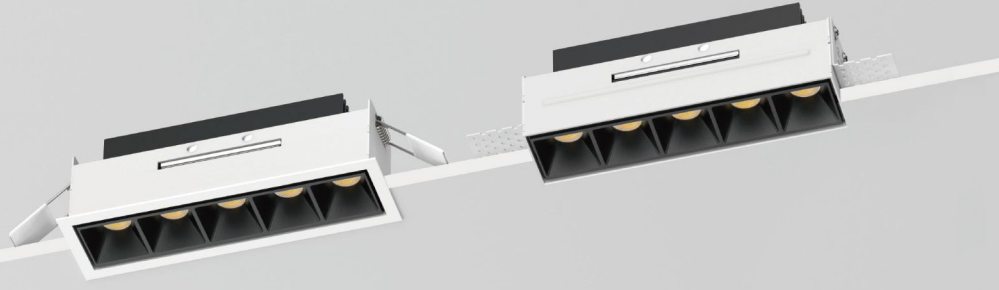

With Trim

Trimless

White

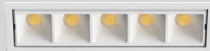

Black

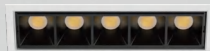

HG-S05QT



40mm
1.57"

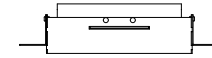

161mm
6.34"

59mm
2.32"



49mm
1.85"

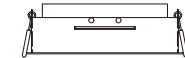

172mm
6.77"

59mm
2.32"

Basic Information

Model	HG-S05QS/S05QT
Embedded Parts	With Trim/Trimless
Mounting	Recessed
Trim Finishing Color	White/Black
Reflector Color	White/Black
Material	Aluminum
Cutout Size	163*44mm
IP Rating	IP20
Power	Max. 12W
Input Voltage	DC15V
Input Current	Max. 750mA

Optical Parameters

Light Source	LED
Lumens	67lm/W
CRI	95Ra
CCT	3000K ● 3500K ● 4000K ○
CCT Changeable	2700K 6000K
Beam Angle	50°
LED Lifespan	50000hrs

Driver Voltage	AC100-120V AC220-240V
Driver Options	ON/OFF DIM TRIAC/ PHASE-CUT DIM 0/1-10V DIM DALI

HIGH Grille Series



HIGH Grille Series

HG-S10QS

HG-S10QT



With Trim

Trimless

White



Black



HG-S10QT

HG-S10QS

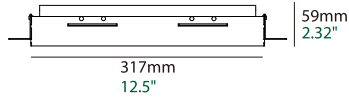

Basic Information

Model	HG-S10QS/S10QT
Embedded Parts	With Trim/Trimless
Mounting	Recessed
Trim Finishing Color	White/Black
Reflector Color	White/Black
Material	Aluminum
Cutout Size	319*44mm
IP Rating	IP20
Power	Max. 24W
Input Voltage	DC30V
Input Current	Max. 750mA

Optical Parameters

Light Source	LED
Lumens	67lm/W
CRI	95Ra
CCT	3000K ● 3500K ● 4000K ○
CCT Changeable	2700K 6000K
Beam Angle	50°
LED Lifespan	50000hrs

Driver Voltage	AC100-120V AC220-240V
Driver Options	ON/OFF DIM TRIAC/ PHASE-CUT DIM 0/1-10V DIM DALI

HIGH Grille Series

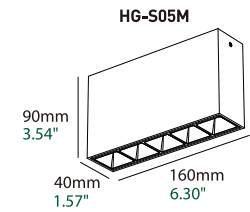

Basic Information

Model	HG-S05M
Mounting	Surface mounted
Trim Finishing Color	White/Black
Reflector Color	White/Black
Material	Aluminum
IP Rating	IP20
Power	Max. 12W
Input Voltage	DC15V
Input Current	Max. 750mA

Optical Parameters

Light Source	LED
Lumens	67lm/W
CRI	95Ra
CCT	3000K ● 3500K ● 4000K ○
CCT Changeable	2700K — 6000K
Beam Angle	▲ 50°
LED Lifespan	50000hrs

Driver Voltage	AC100-120V AC220-240V
Driver Options	ON/OFF DIM TRIAC/ PHASE-CUT DIM 0/1-10V DIM DALI



Gypsum · Concave



SG-S10QT



SG-S10QT

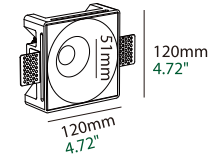

88mm
3.46"

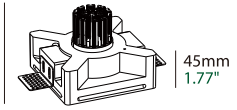

Basic Information

Model	SG-S10QT
Embedded Parts	Trimless
Mounting	Recessed
Finishing Color	White
Material	Gypsum Housing, Aluminium Light Body
Cutout Size	□123*123mm
IP Rating	IP20
Power	Max. 15W
Input Voltage	DC36V
Input Current	Max. 350mA

Optical Parameters

Light Source	LED COB
Lumens	65lm/W
CRI	97Ra
CCT	3000K ● 3500K ● 4000K ○
CCT Changeable	2700K — 6000K 1800K — 3000K
Beam Angle	▼ 25° ▼ 60°
Shielding Angle	39°
LED Lifespan	50000hrs



Split Design

LED COB Light Source

Cold Forged Pure Alu. Heat Sink

Driver Voltage	AC100-120V AC220-240V
Driver Options	ON/OFF DIM TRIAC/ PHASE-CUT DIM 0/1-10V DIM DALI

Gypsum Series

SG-S05QT

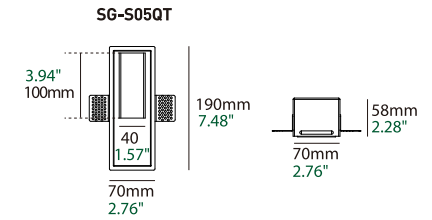

Basic Information

Model	SG-S05QT
Embedded Parts	Trimless
Mounting	Recessed
Finishing Color	White
Material	Gypsum Housing, Aluminium Light Body
Cutout Size	□ L193*W73*D58
IP Rating	IP20
Power	Max. 3W
Input Voltage	DC3V
Input Current	Max. 350mA

Optical Parameters

Light Source	LED COB
Lumens	42lm/W
CRI	95Ra
CCT	3000K ● 3500K ● 4000K ○
Beam Angle	▲ 50°
LED Lifespan	50000hrs

Driver Voltage	AC100-250V
Driver Options	ON/OFF

Gypsum·Square

Gypsum Series

SG-S04QT

Gypsum Series

Gypsum·Circle

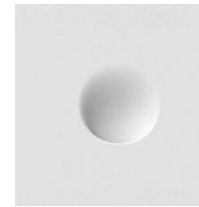

SG-S04QT

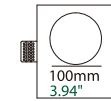

185mm
7.28"

55mm
2.17"

Basic Information

Model	SG-S04QT
Embedded Parts	Trimless
Mounting	Recessed
Finishing Color	White
Material	Gypsum Housing, Aluminium Light Body
Cutout Size	□L187*W153*D58
IP Rating	IP20
Power	Max. 3W
Input Voltage	DC3V
Input Current	Max. 350mA

Optical Parameters

Light Source	LED COB
Lumens	42lm/W
CRI	95Ra
CCT	3000K ● 3500K ● 4000K ○
Beam Angle	▲ 50°
LED Lifespan	50000hrs

Driver Voltage AC100-250V

Driver Options ON/OFF



Intertek

M19 Magnetic Track System

Magnetic Track System

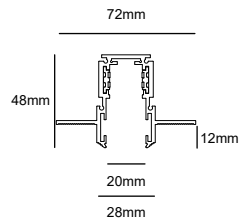
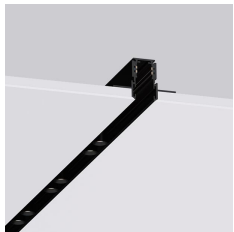

1.5M/2M
M19A
Embedded

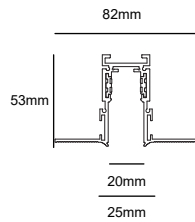
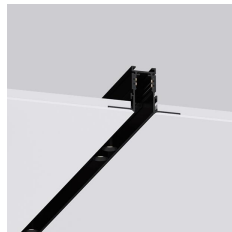

1.5M/2M
M19T
Embedded

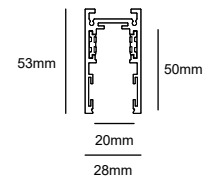

1.5M/2M
M19H
Surface Mounted

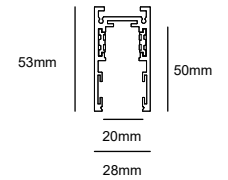

1.5M/2M
M19H
Hanging

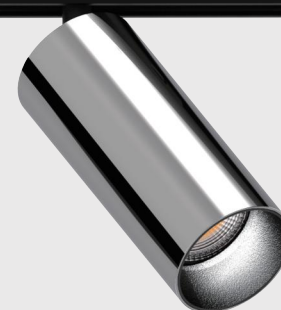
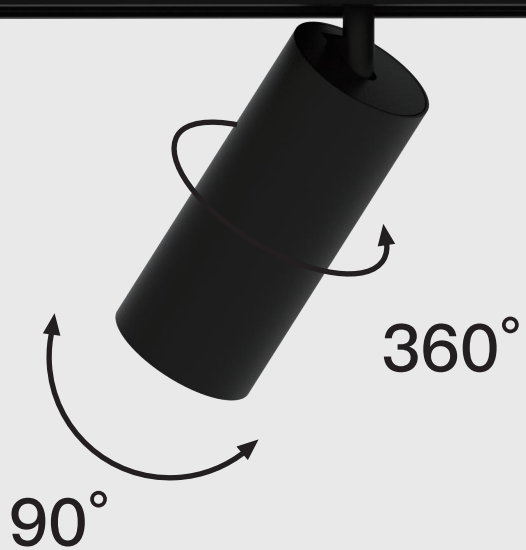

Track Spotlight

- M19 SP30 6W
- M19 SP40 10W
- M19 SP55 15W
- M19 SP36 8W



↻ 90° ↻ 360°

- Grille mini spots recessed in the track, wide lighting area;
Freely move, freely directional;
- The design concept is, Less is more, looks uniform and neat;

20mm



Magnetic Track System

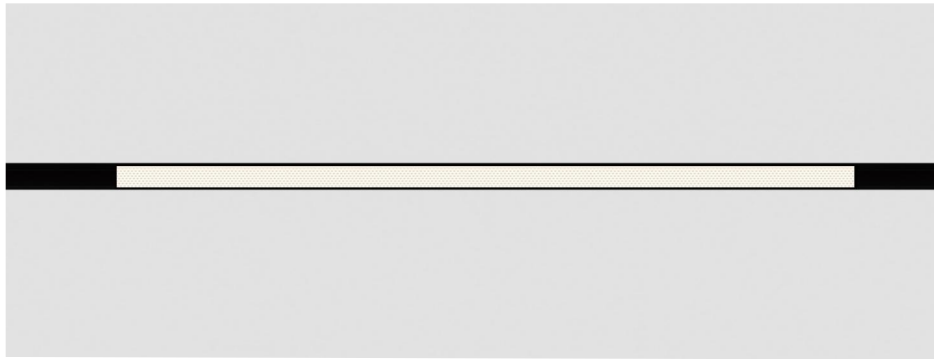

Model: M19 FL40



Product Parameters

Chip	Power	CRI	CCT	Beam Angle
HOUNOURTEK	15W	≥95	<ul style="list-style-type: none"> ● 3000K ● 3500K ● 4000K 	120°

Color Black

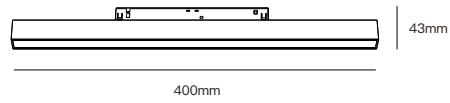

Model: M19 FL80



Product Parameters

Chip	Power	CRI	CCT	Beam Angle
HOUNOURTEK	30W	≥95	<ul style="list-style-type: none"> ● 3000K ● 3500K ● 4000K 	120°

Color Black

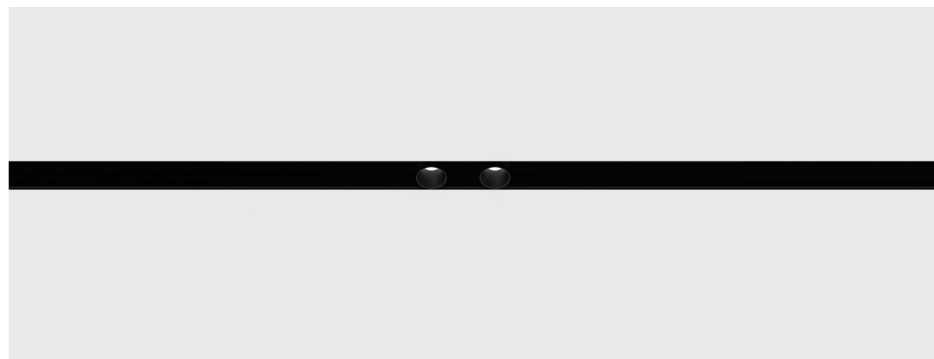
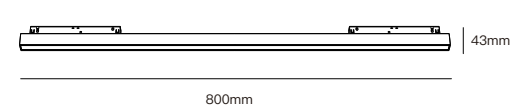

Model: M19 GL02



Product Parameters

Chip	Power	CRI	CCT	Beam Angle
HOUNOURTEK	4W	≥95	<ul style="list-style-type: none"> ● 3000K ● 3500K ● 4000K 	35°

Color Black

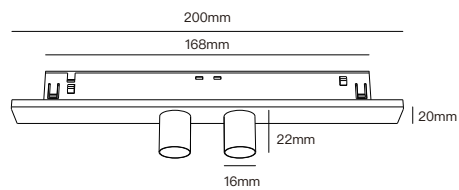

Model: M19 GL04



Product Parameters

Chip	Power	CRI	CCT	Beam Angle
HOUNOURTEK	8W	≥95	<ul style="list-style-type: none"> ● 3000K ● 3500K ● 4000K 	35°

Color Black

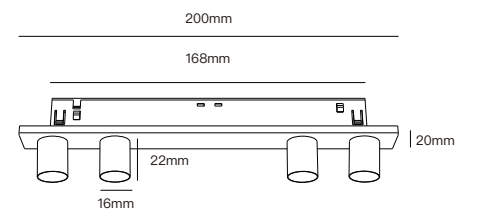

Magnetic Track System

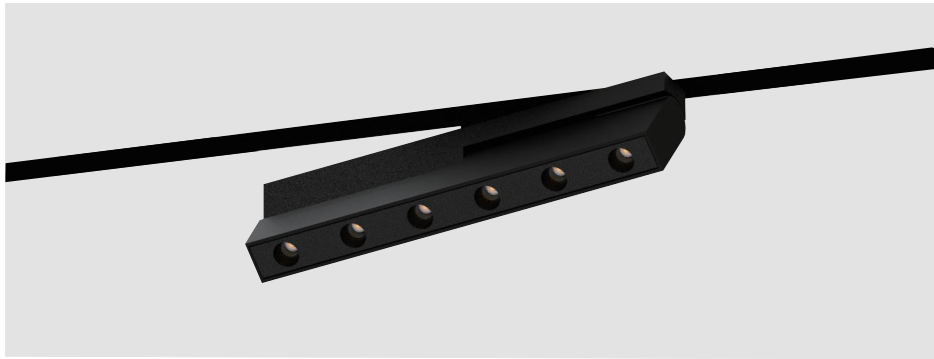

Model: M19 GF20



Product Parameters

Chip	Power	CRI	CCT	Beam Angle	Adjustable
HOUNOURTEK	10W	≥95	<ul style="list-style-type: none"> ● 3000K ● 3500K ● 4000K 	<ul style="list-style-type: none"> ▮ 35° 	<ul style="list-style-type: none"> ⊖ 90° ⊕ 360°

Color ■ Black

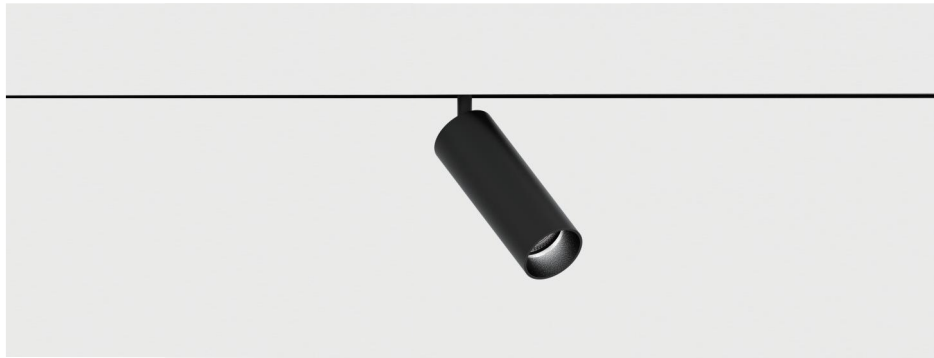
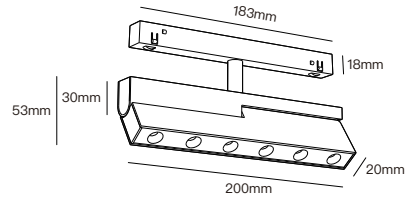

Model: M19 SP30



Product Parameters

Chip	Power	CRI	CCT	Beam Angle	Adjustable
HOUNOURTEK Full-spectrum	6W	≥97	<ul style="list-style-type: none"> ● 3000K ● 3500K ● 4000K 	<ul style="list-style-type: none"> ▮ 35° 	<ul style="list-style-type: none"> ⊖ 90° ⊕ 360°

Color ■ Black

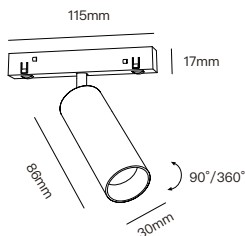

Model: M19 GL20



Product Parameters

Chip	Power	CRI	CCT	Beam Angle
HOUNOURTEK	10W	≥95	<ul style="list-style-type: none"> ● 3000K ● 3500K ● 4000K 	<ul style="list-style-type: none"> ▮ 35°

Color ■ Black

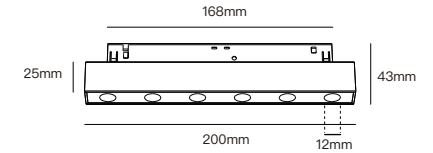

Model: M19 SP40



Product Parameters

Chip	Power	CRI	CCT	Beam Angle	Adjustable
HOUNOURTEK Full-spectrum	10W	≥97	<ul style="list-style-type: none"> ● 3000K ● 3500K ● 4000K 	<ul style="list-style-type: none"> ▮ 10° ▮ 25° ▮ 35° 	<ul style="list-style-type: none"> ⊖ 90° ⊕ 360°

Color ■ Black

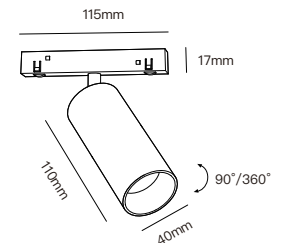

Magnetic Track System



Model: M19 SP55



Product Parameters

Chip	Power	CRI	CCT	Beam Angle	Adjustable
Bridgelux	15W	≥97	<ul style="list-style-type: none"> ● 3000K ● 3500K ● 4000K 	<ul style="list-style-type: none"> ▮ 35° ▮ 50° 	<ul style="list-style-type: none"> ↺ 90° ↻ 360°

Color ■ Black

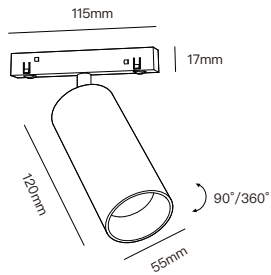

Model: M19 SP36



Product Parameters

Chip	Power	CRI	CCT	Beam Angle
HOUNOURTEK Full-spectrum	8W	≥97	<ul style="list-style-type: none"> ● 3000K ● 3500K ● 4000K 	/

Color ■ Black

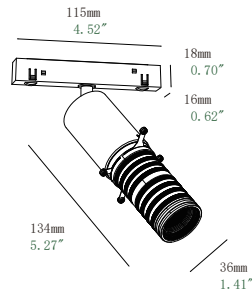

Model: M19 XP55



Product Parameters

Chip	Power	CRI	CCT	Beam Angle
HOUNOURTEK Full-spectrum	8W	≥97	<ul style="list-style-type: none"> ● 3000K ● 3500K ● 4000K 	▮ 35°

Color ■ Black

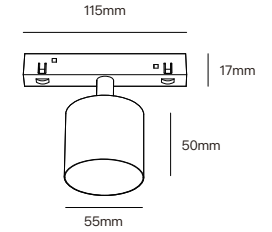

Magnetic Track System

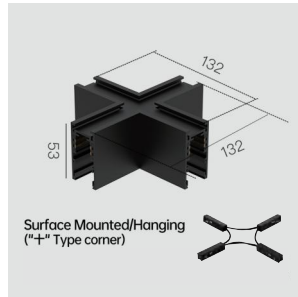
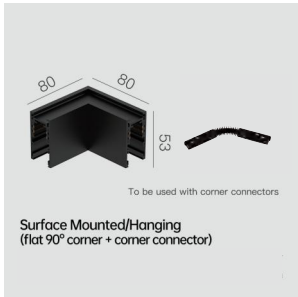
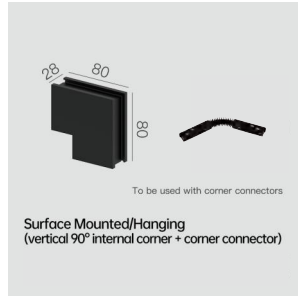
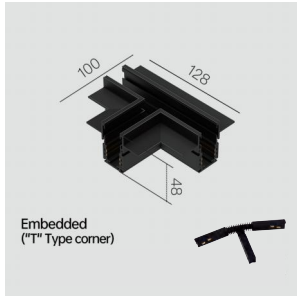
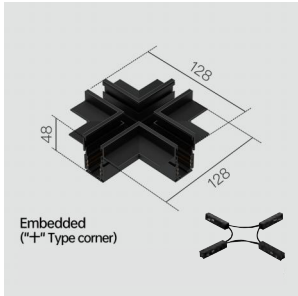
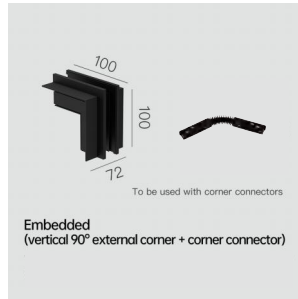
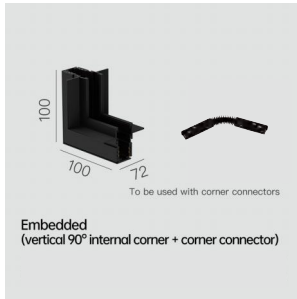
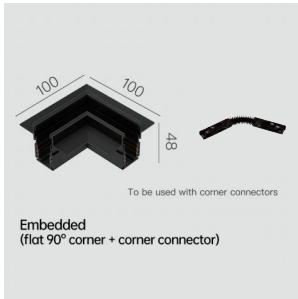

ER-S50M



White

Black

Silver

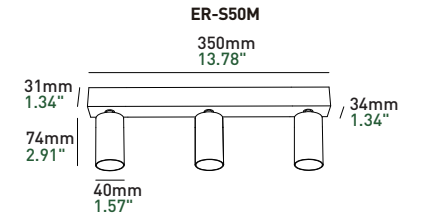
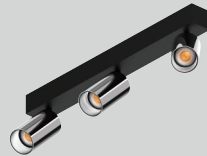

Surface Mounted Series

Basic Information

Model	ER-S50M
Mounting	Surface
Reflector Color	White/Black/Silver
Material	Aluminum
Light Direction	⬇️ 90° ⬅️ 360°
IP Rating	IP20
Power	Max. 8W*3
Input Voltage	DC36V
Input Current	Max. 200mA*3

Optical Parameters

Light Source	LED COB
Lumens	65lm/W
CRI	97Ra
CCT	3000K ● 3500K ● 4000K ○
CCT Changeable	2700K — 6000K 1800K — 3000K
Beam Angle	▲ 15° ▲ 25° ▲ 35°
UGR	< 9
LED Lifespan	50000hrs

Driver Voltage	AC100-120V AC220-240V
Driver Options	ON/OFF DIM TRIAC/ PHASE-CUT DIM 0/1-10V DIM DALI

GN45P-R01M



White



Black



Silver



Brushed Aluminum



GN45P-R01M

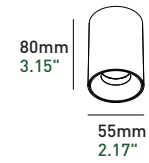

Basic Information

Model	GN45P-R01M
Mounting	Surface
Reflector Color	White/Black/Silver/Brushed Aluminum
Material	Aluminum
IP Rating	IP20
Power	Max.8W
Input Voltage	DC36V
Input Current	Max. 200mA

Optical Parameters

Light Source	LED COB
Lumens	65lm/W
CRI	97Ra
CCT	3000K ● 3500K ● 4000K ○
CCT Changeable	2700K — 6000K 1800K — 3000K
Beam Angle	▲ 15° ▲ 25° ▲ 35°
UGR	< 9
LED Lifespan	50000hrs

Driver Voltage AC100-120V AC220-240V

Driver Options ON/OFF DIM TRIAC/ PHASE-CUT DIM 0/1-10V DIM DALI

MZZ10



White



Silver



Black

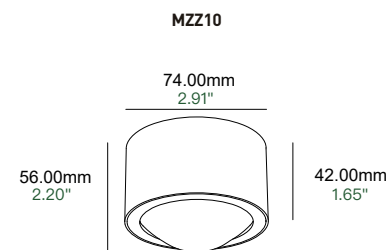

Basic Information

Model	MZZ10
Mounting	Surface
Reflector Color	White/Black/Silver
Material	Pure aluminum 6063
IP Rating	IP20
Power	Max.8W
Input Voltage	DC36V
Input Current	Max. 200mA

Optical Parameters

Light Source	LED COB
Lumens	62lm/W
CRI	97Ra
CCT	2700K ● 3000K ● 3500K ● 4000K ○
LED Lifespan	50000hrs

Driver Voltage	AC100-120V AC220-240V
Driver Options	ON/OFF DIM TRIAC/ PHASE-CUT DIM 0/1-10V DIM DALI

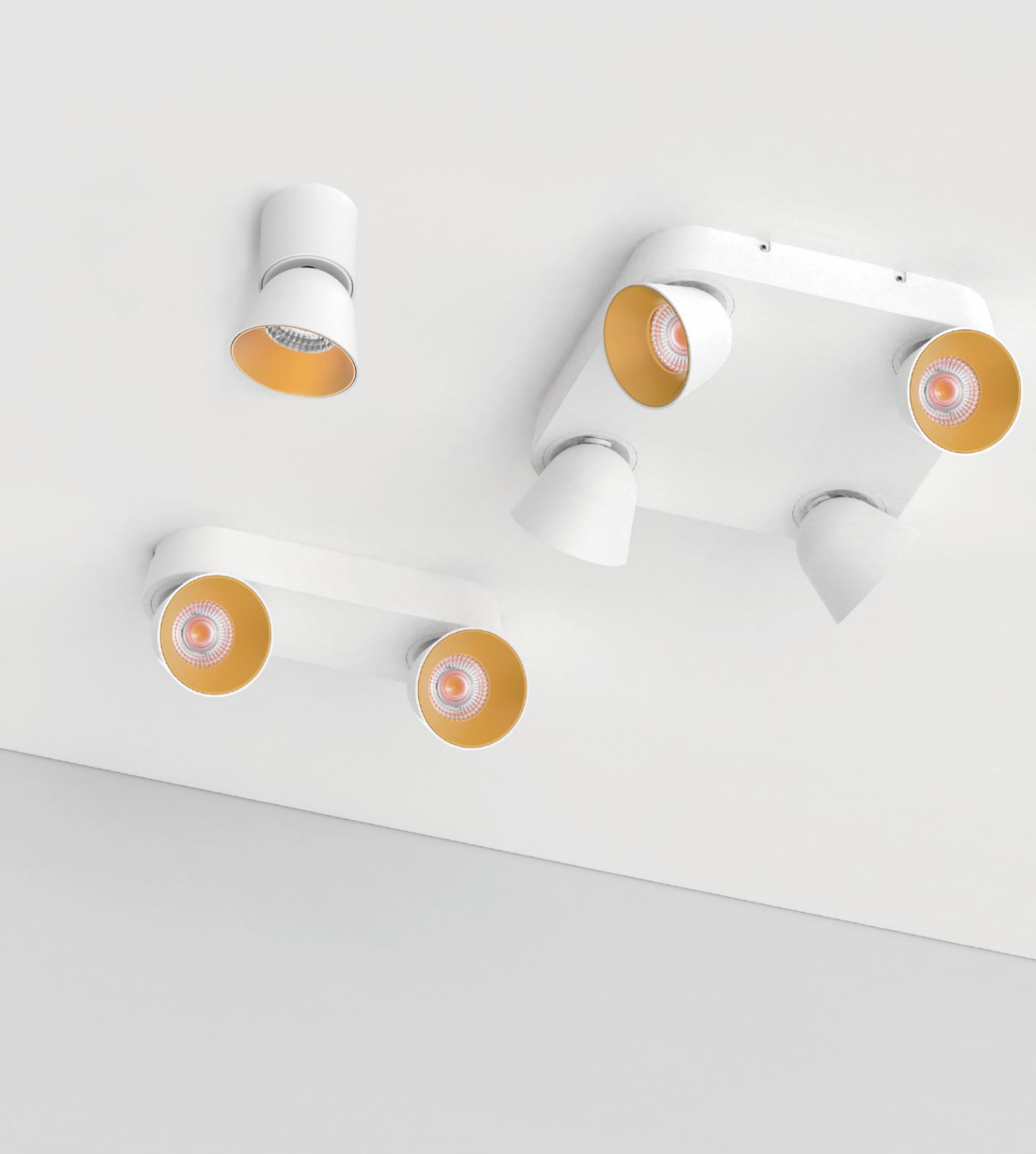

WIND CHIME

WT+WT

WT+BK

WT+GD

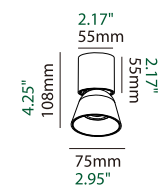
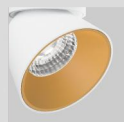

MPR01 (Power: 10W)

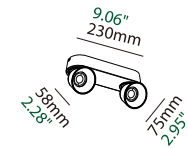

MPR02 (Power: 15W)

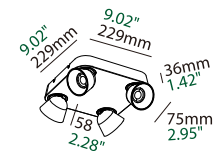

MPR04 (Power: 30W)

Basic Information

Mounting	Surface mounted
Finishing Color	White
Reflector Color	White/Black/Golden
Material	Die-cast Aluminum
Light Direction	55° 355°
IP Rating	IP20
Led Voltage	DC36V

Optical Parameters

Light Source	LED COB
Lumens	70lm/W
CRI	97Ra
CCT	3000K 3500K 4000K
CCT Changeable	2700K 6000K 1800K 3000K
Beam Angle	50°
UGR	< 13
LED Lifespan	50000hrs

Driver Voltage	AC100-120V AC220-240V
Driver Options	ON/OFF DIM TRIAC/ PHASE-CUT DIM 0/1-10V DIM DALI

Ceiling Light

MYP02/04



Ceiling Light

AURORA

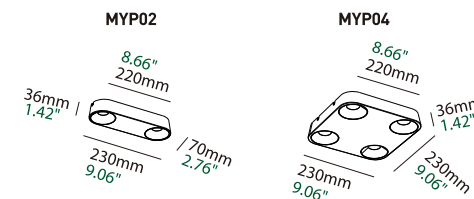

Basic Information

Model	MYP02/04
Mounting	Surface mounted
Color	White
Material	Aluminum
IP Rating	IP20
Power	Max. 12W / Max. 24W
Led Voltage	DC36V
Input Current	Max. 300mA / Max. 600mA

Optical Parameters

Light Source	LED COB
Lumens	65lm/W 90lm/W
CRI	97Ra / 90Ra
CCT	3000K ● 3500K ● 4000K ○
CCT Changeable	2700K — 6000K 1800K — 3000K
Beam Angle	60°
UGR	< 16
LED Lifespan	50000hrs

Driver Voltage	AC100-120V AC220-240V
Driver Options	ON/OFF DIM TRIAC/ PHASE-CUT DIM 0/1-10V DIM DALI

MCR45



SUNSET

WT+WT

WT+GD



BK+BK

BK+GD

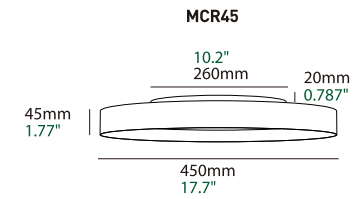

Basic Information

Model	MCR45
Mounting	Surface mounted
Finishing Color	White/Black
Inside Circle Color	White/Black/Golden
Material	Aluminum
IP Rating	IP20
Power	Max. 40W
Led Voltage	DC36V
Input Current	Max. 1000mA

Optical Parameters

Light Source	LED
Lumens	59lm/W
CRI	95Ra
CCT	3000K ● 3500K ● 4000K ○
Beam Angle	120°
UGR	< 13
LED Lifespan	50000hrs

Driver Voltage	AC100-120V AC220-240V
Driver Options	ON/OFF DIM TRIAC/ PHASE-CUT DIM 0/1-10V DIM DALI



Decor Lights

DXH-02 Astro



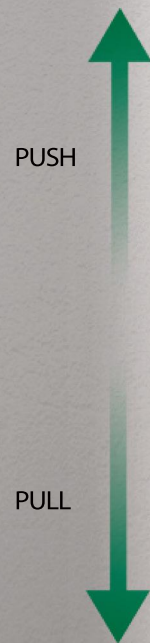

PUSH

PULL



Freely hover at a desired height

DXH-02 Astro

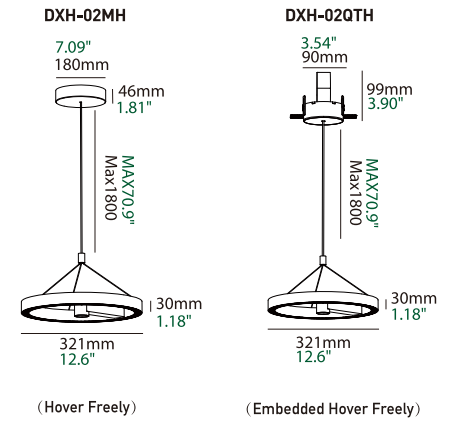

Basic Information

Model	DXH-02MH/DXH-02QTH
Mounting	Surface mounted/Recessed
Color	Black
Material	Aluminum
IP Rating	IP20
Power	Max. 30W
Led Voltage	DC36V
Input Current	Max. 800mA

Optical Parameters

Light Source	LED
Lumens	52lm/W
CRI	97Ra
CCT	3000K <input type="radio"/> 3500K <input type="radio"/> 4000K <input type="radio"/>
CCT Changeable	2700K <input type="checkbox"/> 6000K <input type="checkbox"/>
Beam Angle	60° + 120°
LED Lifespan	50000hrs

Driver Voltage	AC100-120V AC220-240V
Driver Options	ON/OFF DIM TRIAC/ PHASE-CUT DIM 0/1-10V DIM DALI

Game Pole

lamp length 1200mm,
the luminous surface length 1196mm

DZZ-02M



DZZ-02M

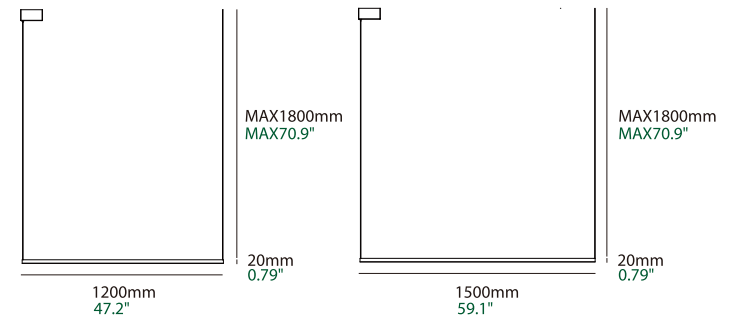

Basic Information

Model	DZZ-02M
Mounting	Surface mounted
Length	1.2m/1.5m
Color	Black
Material	Aluminum
IP Rating	IP20
Power	Max. 18W / Max. 24W
Led Voltage	DC36V
Input Current	Max. 450mA/ Max. 600mA

Optical Parameters

Light Source	LED
Lumens	40lm/W
CRI	97Ra
CCT	3000K ● 3500K ● 4000K ○
CCT Changeable	2700K 6000K
Beam Angle	120°
LED Lifespan	50000hrs

Driver Voltage	AC100-120V AC220-240V
Driver Options	ON/OFF DIM TRIAC/ PHASE-CUT DIM 0/1-10V DIM DALI

DZZ-04

YEXI

Decor Lights



DZZ-04

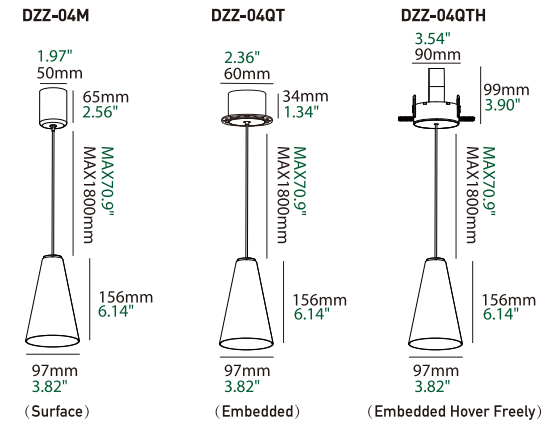

Basic Information

Model	DZZ-04M/04QT/04QTH
Mounting	Surface mounted/Recessed
Color	White/Black
Material	Aluminum
IP Rating	IP20
Power	Max. 6W
Led Voltage	DC36V
Input Current	Max. 150mA

Optical Parameters

Light Source	LED COB
Lumens	72lm/W
CRI	98Ra
CCT	3000K ● 3500K ● 4000K ○
CCT Changeable	2700K — 6000K 1800K — 3000K
Beam Angle	▲ 60°
LED Lifespan	50000hrs

Driver Voltage	AC100-120V AC220-240V
Driver Options	ON/OFF DIM TRIAC/ PHASE-CUT DIM 0/1-10V DIM DALI

DZZ-05

SAURI



Decor Lights

DZZ-05



DZZ-05M

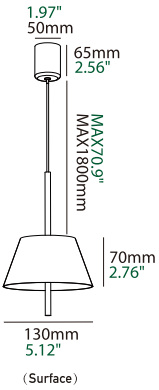

DZZ-05QT

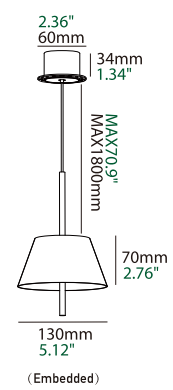

DZZ-05QTH

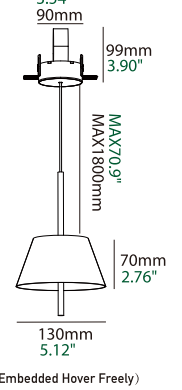

Basic Information

Model	DZZ-05M/05QT/05QTH
Mounting	Surface mounted/Recessed
Color	Black+Golden/White+Golden
Material	Aluminum
IP Rating	IP20
Power	Upward 2W / Downward 6W
Led Voltage	DC36V
Input Current	Max. 200mA

Optical Parameters

Light Source	LED
Lumens	52lm/W
CRI	97Ra
CCT	3000K ● 3500K ● 4000K ○
CCT Changeable	2700K 6000K
Beam Angle	120°
LED Lifespan	50000hrs

Driver Voltage	AC100-120V AC220-240V
Driver Options	ON/OFF DIM TRIAC/ PHASE-CUT DIM 0/1-10V DIM DALI



DZZ-06

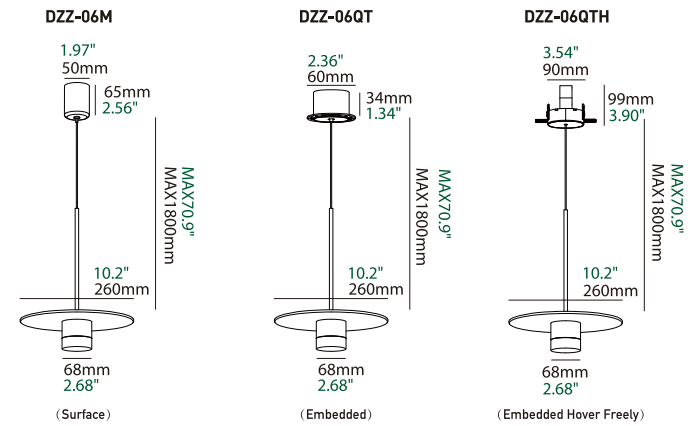

Basic Information

Model	DZZ-06M/06QT/06QTH
Mounting	Surface mounted/Recessed
Color	Black+Golden
Material	Aluminum
IP Rating	IP20
Power	Max. 8W
Led Voltage	DC36V
Input Current	Max. 200mA

Optical Parameters

Light Source	LED COB
Lumens	60lm/W
CRI	98Ra
CCT	3000K ● 3500K ● 4000K ○
CCT Changeable	2700K 6000K 1800K 3000K
Beam Angle	20°- 50° Adjustable
LED Lifespan	50000hrs

Driver Voltage	AC100-120V AC220-240V
Driver Options	ON/OFF DIM TRIAC/ PHASE-CUT DIM 0/1-10V DIM DALI



NIMO Series

DYY-01M



DYY-01M

1.97"
50mm



90mm
3.54"

Basic Information

Model	DYY-01M
Mounting	Surface mounted
Color	Black
Material	Aluminum
IP Rating	IP20
Power	Max. 8W
Led Voltage	DC36V
Input Current	Max. 200mA

Optical Parameters

Light Source	LED COB
Lumens	68lm/W
CRI	98Ra
CCT	3000K ● 3500K ● 4000K ○
CCT Changeable	2700K — 6000K 1800K — 3000K
Beam Angle	▲ 50°
LED Lifespan	50000hrs

Driver Voltage	AC100-120V AC220-240V
Driver Options	ON/OFF DIM TRIAC/ PHASE-CUT DIM 0/1-10V DIM DALI

DYY-03M

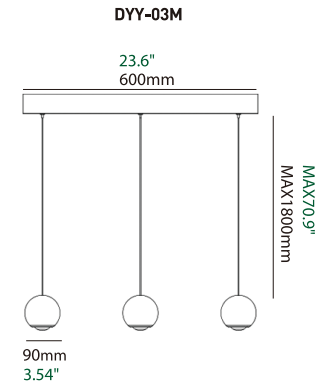
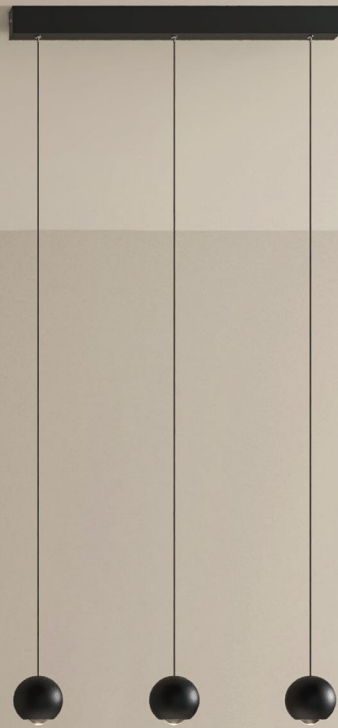

Basic Information

Model	DYY-03M
Mounting	Surface mounted
Color	Black
Material	Aluminum
IP Rating	IP20
Power	Max.8W*3
Led Voltage	DC36V
Input Current	Max. 200mA*3

Optical Parameters

Light Source	LED COB
Lumens	68lm/W
CRI	98Ra
CCT	3000K ● 3500K ● 4000K ○
CCT Changeable	2700K — 6000K 1800K — 3000K
Beam Angle	▲ 50°
LED Lifespan	50000hrs

Driver Voltage	AC100-120V AC220-240V
Driver Options	ON/OFF DIM TRIAC/ PHASE-CUT DIM 0/1-10V DIM DALI

Decor Lights

DYY-03MS/05MS



DYY-03MS

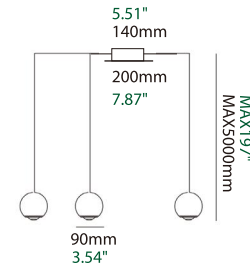

DYY-05MS

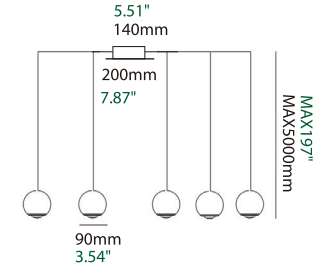

Basic Information

Model	DYY-03MS/DYY-05MS
Mounting	Surface mounted
Color	Black
Material	Aluminum
IP Rating	IP20
Power	Max. 3*8W / Max. 5*8W
Led Voltage	DC36V
Input Current	Max. 200mA*3 / Max. 200mA*5

Optical Parameters

Light Source	LED COB
Lumens	68lm/W
CRI	98Ra
CCT	3000K ● 3500K ● 4000K ○
CCT Changeable	2700K — 6000K 1800K — 3000K
Beam Angle	▲ 50°
LED Lifespan	50000hrs

Driver Voltage	AC100-120V AC220-240V
Driver Options	ON/OFF DIM TRIAC/ PHASE-CUT DIM 0/1-10V DIM DALI

Decor Lights

DYY-09

Decor Lights

Galaxy



DYY-09



DYY09

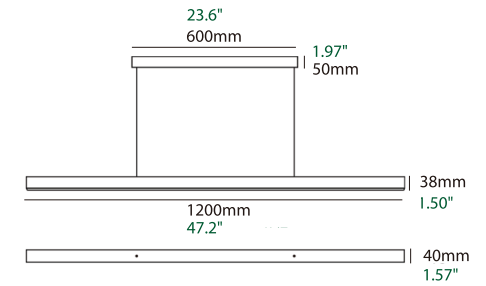

Basic Information

Model	DYY-09
Mounting	Surface mounted
Length	1.2m
Color	White/Black
Material	Aluminum
IP Rating	IP20
Power	Max.25W
Led Voltage	DC36V
Input Current	Max. 700mA

Optical Parameters

Light Source	LED
Lumens	55lm/W
CRI	97Ra
CCT	3000K <input type="radio"/> 3500K <input type="radio"/> 4000K <input type="radio"/>
CCT Changeable	2700K <input type="range"/> 6000K
Beam Angle	120°
LED Lifespan	50000hrs

Driver Voltage	AC100-120V AC220-240V
Driver Options	ON/OFF DIM TRIAC/ PHASE-CUT DIM 0/1-10V DIM DALI

Decor Lights

Bubble →





MQQ02

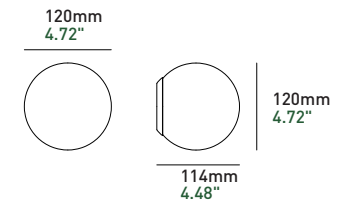

Basic Information

Model	MQQ02
Mounting	Wall-mounted
Reflector Color	White
Material	Glass
IP Rating	IP20
Power	Max.6W
Input Voltage	DC36V
Input Current	Max. 150mA

Optical Parameters

Light Source	LED COB
Lumens	65lm/W
CRI	97Ra
CCT	3000K ● 3500K ● 4000K ○
LED Lifespan	50000hrs

Driver Voltage	AC100-120V AC220-240V
Driver Options	ON/OFF DIM TRIAC/ PHASE-CUT